

Top View

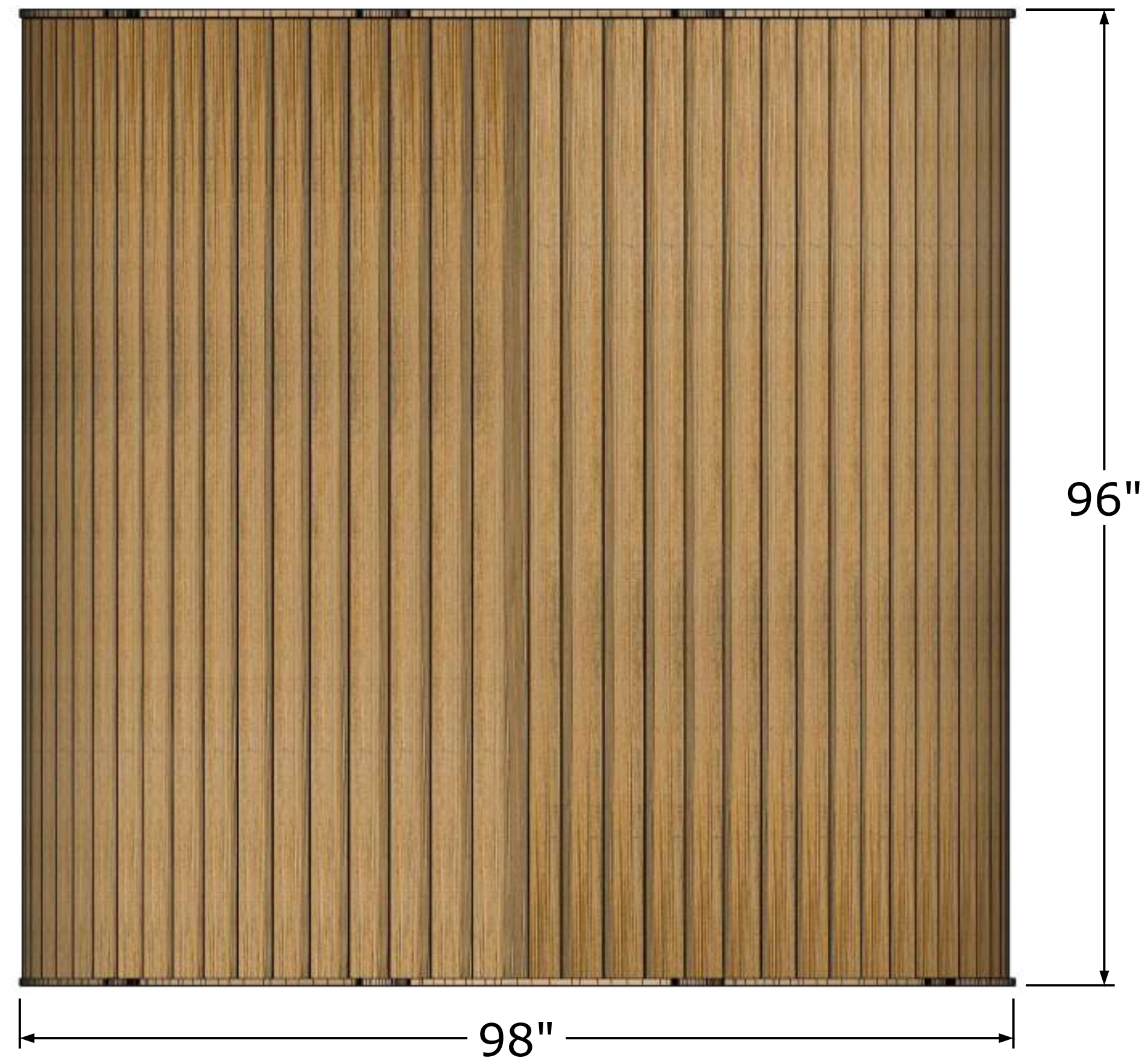

Perspective View



Front View

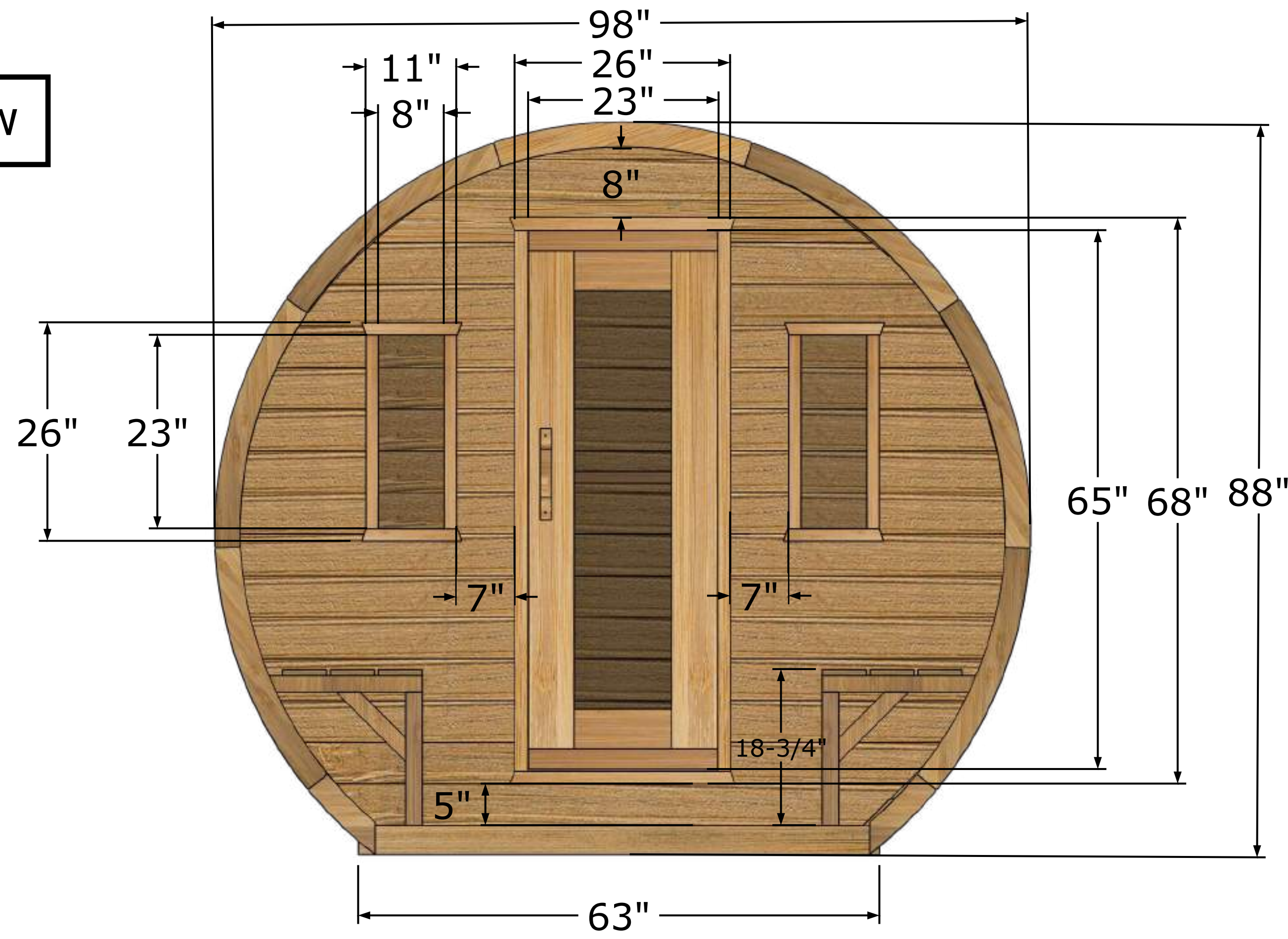

Side View

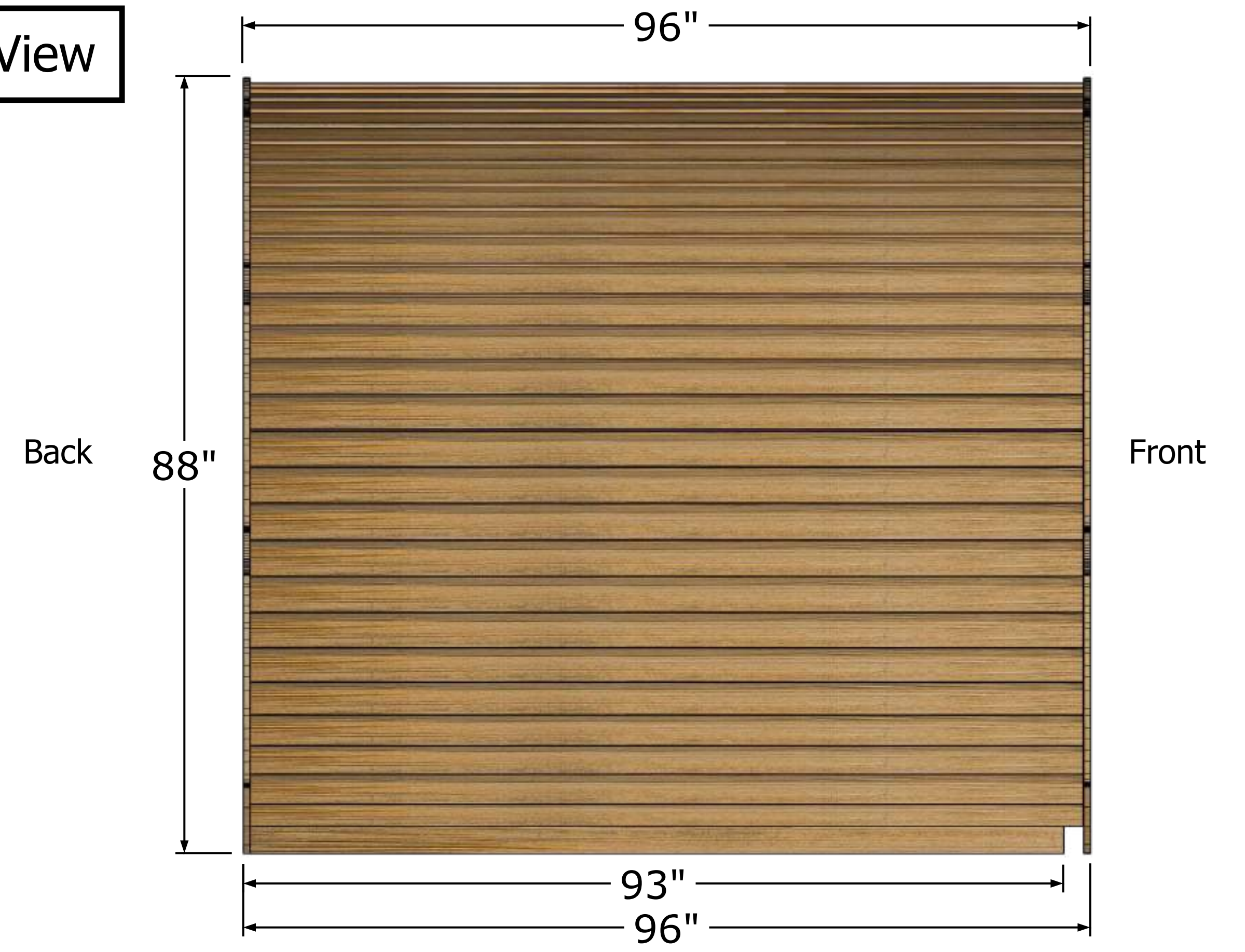

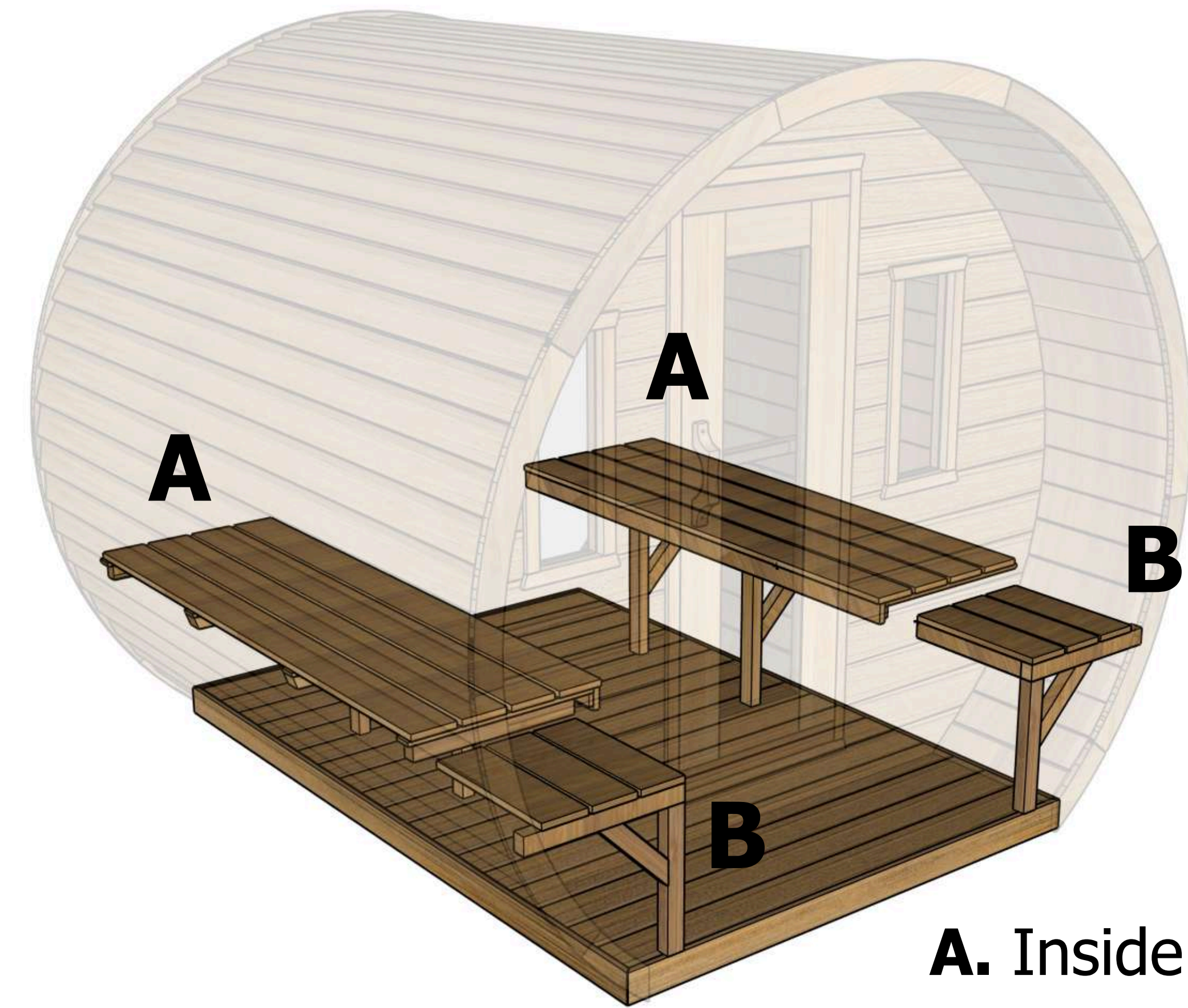
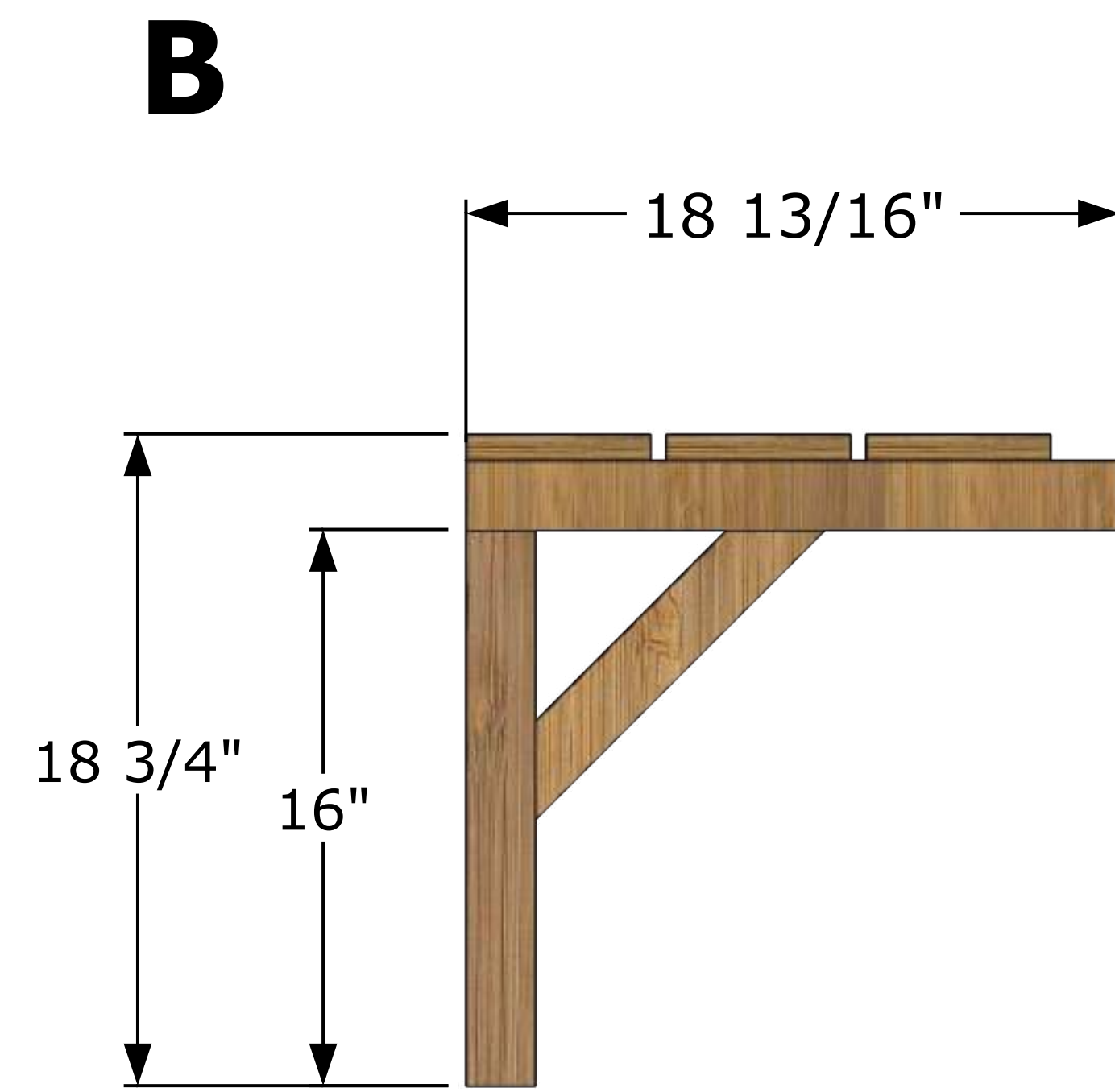
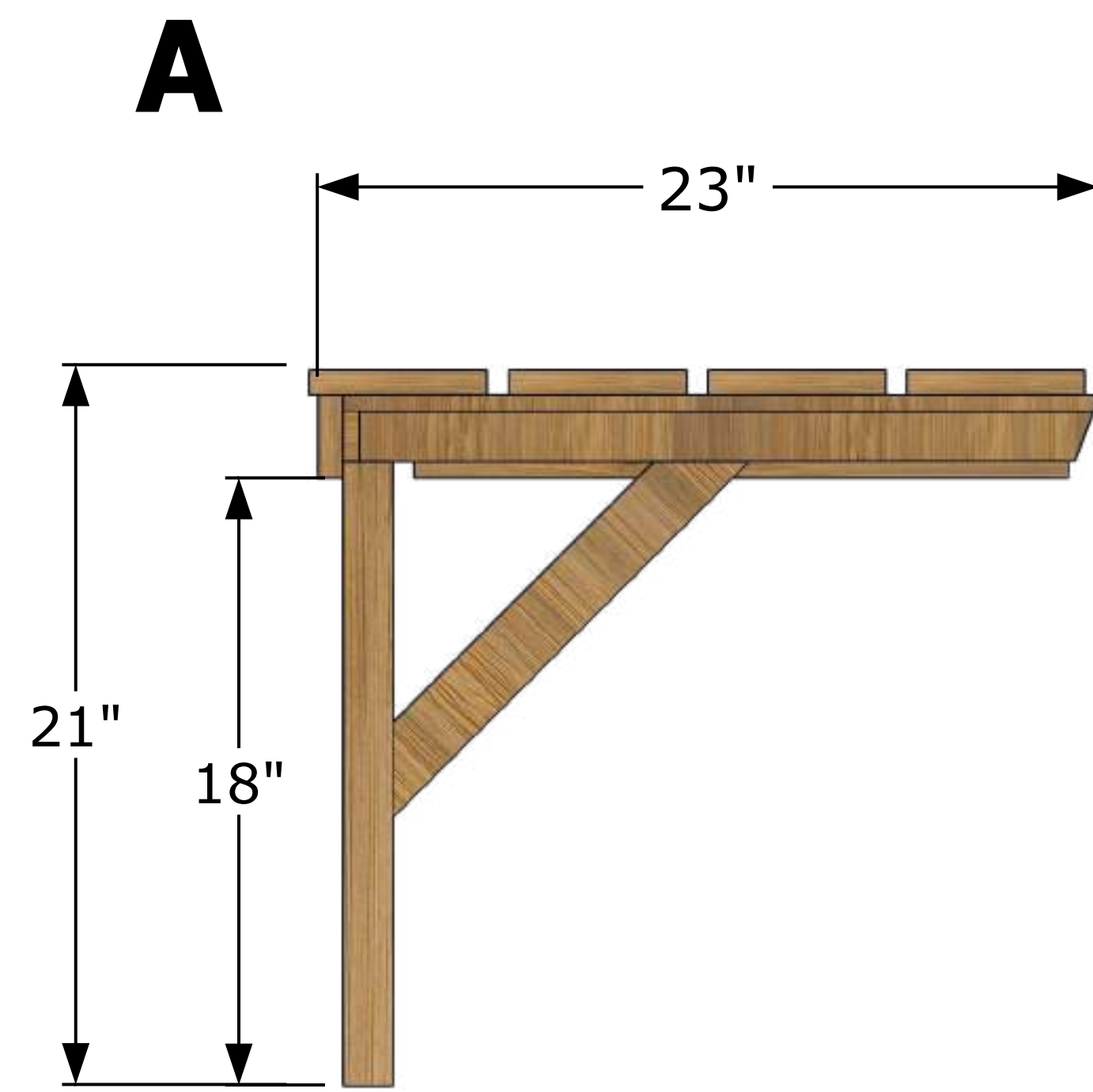

**A.** Inside Benches  
**B.** Outside Benches

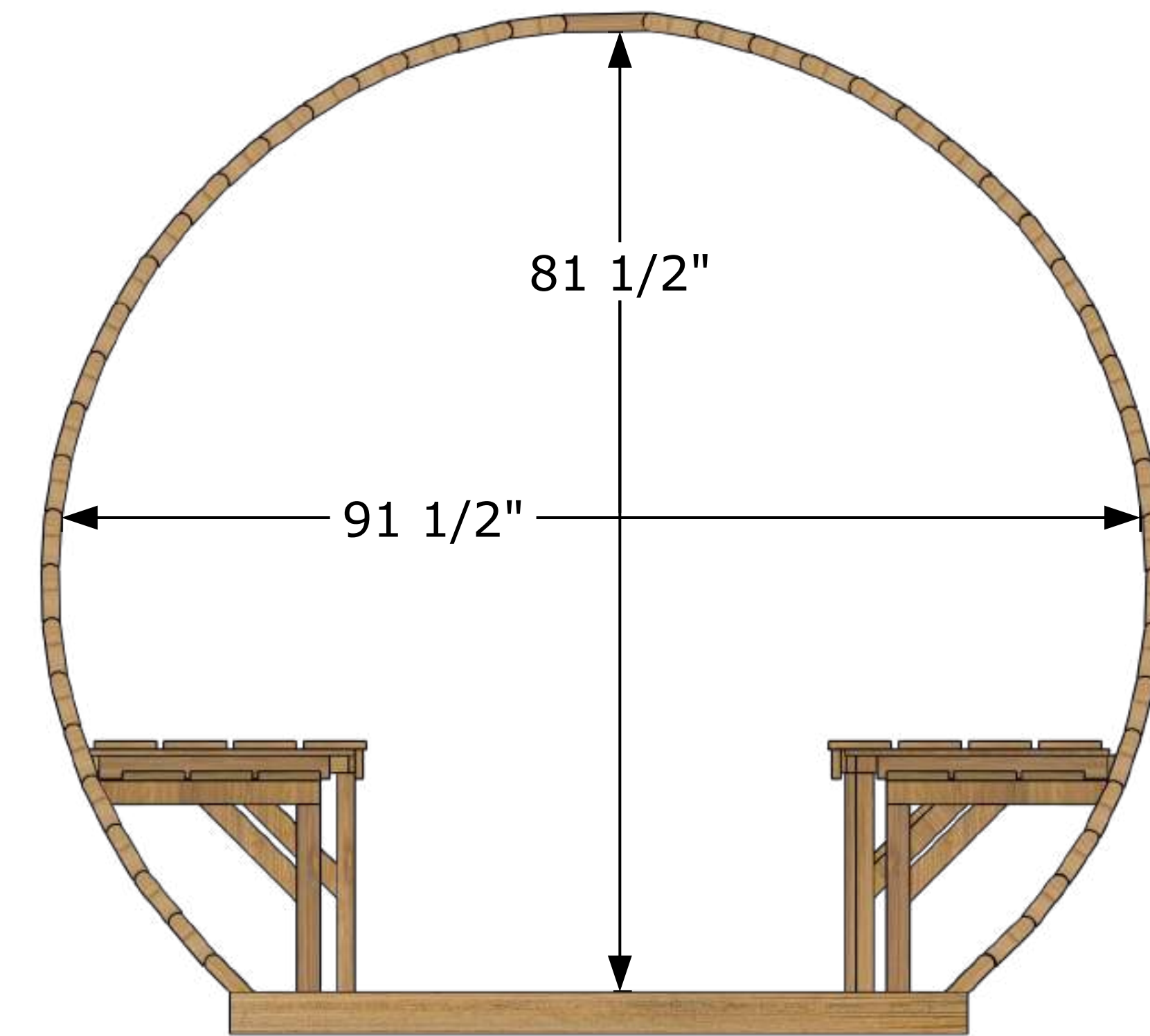
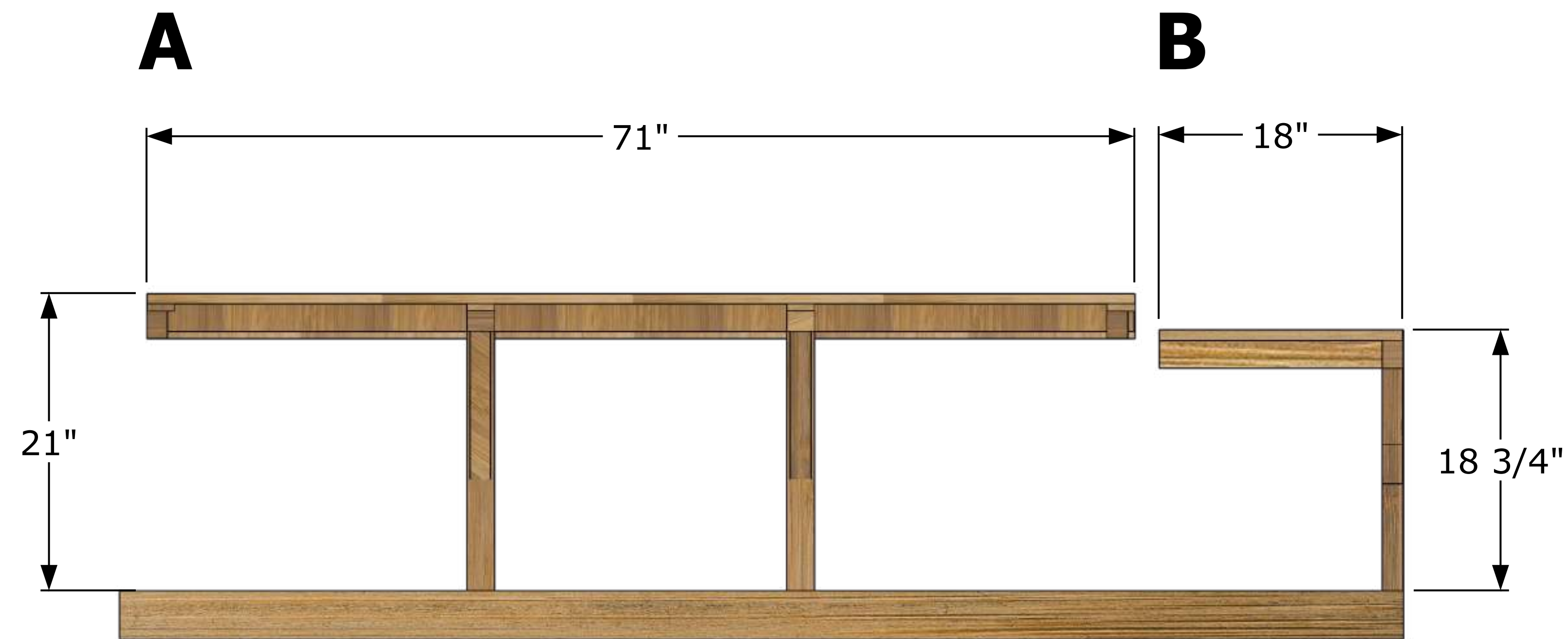



# ASSEMBLY INSTRUCTIONS

for

# ELATION SAUNA

Read these assembly instructions and the accompanying video to enhance your building experience.



Other fine products by Leisure Craft



[www.leisurecraft.com](http://www.leisurecraft.com)

# Table of Contents

TOOLS CHECKLIST	Pg 4
SAUNA BASE PREPARATION	Pg 5
BOTTOM FRAME assembly	Pg 6-11
BACK WALL assembly	Pg 12,17
SIDE WALL assembly	Pg 13, 18-25
FRONT WALL assembly	Pg 14-16
DOOR assembly	Pg 26-27, 40
ICE SHIELD installation	Pg 28-30
SHINGLE installation	Pg 31-32
BENCH assembly	Pg 33-39
VENT installation	Pg 41-44
Accessory installation	Pg 45-46
Sauna Stains and Finishes	Pg 47
Maintaining your sauna	Pg 48
Warranty	Pg 49

# CONGRATULATIONS

on the purchase of your  
**Canadian Timber Elation Sauna**

**Just a few things to follow.....**

**Please be sure to read this entire manual  
Before proceeding with the assembly.**

All electrical connections must be performed  
By a qualified electrician.



For further information about your heater and  
Installation instructions, please refer to the  
provided heater manual.



Always ensure that you have the correct screw  
length so that the screw does not go all the way  
through the material and come out the other side.



# TOOLS CHECKLIST

Ensure you have the following tools to finish the job right!

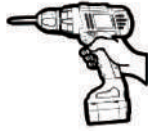

Cordless Driver



2" Hole Saw with bit for cordless driver or drill. 1 1/2" size minimum



#3 Robertson Bit (Short & 4" or longer)

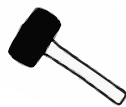

Mallet

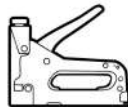

Staple Gun



Nail Gun



Utility Knife



Hammer for optional thermostat



# SAUNA BASE PREPARATION

Ensure the base for your sauna is level with a slight slope to the back for drainage. A solid base for your sauna is recommended and can be made from the following.



Crushed Stone



Patio Stone/Paver Blocks



Concrete Pad

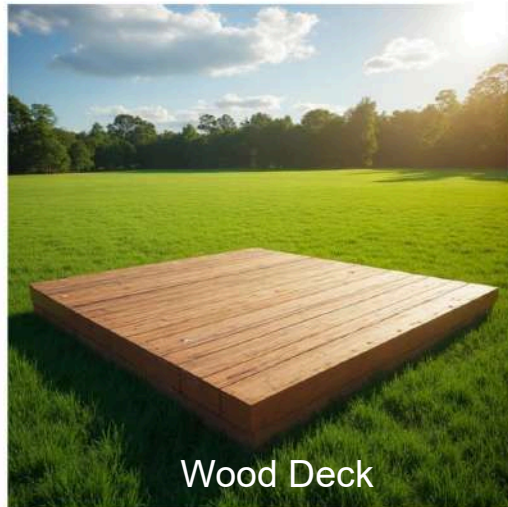

Wood Deck

It is recommended to build a base larger than required to provide a sitting area for cooling off during your sauna session.



# ASSEMBLY INSTRUCTIONS

1

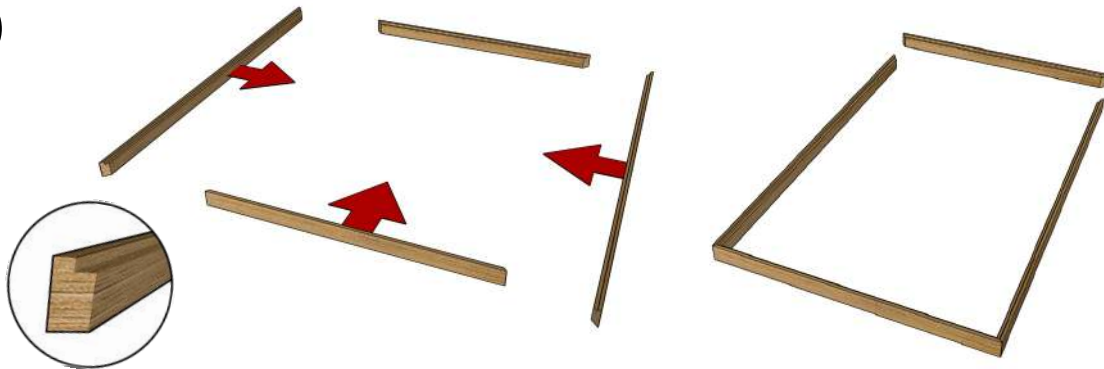

On a flat open space connect three boards leaving the fourth to the side.  
Ensure the groove on the board is facing upwards.

2

 **6X**  
3" Robertson

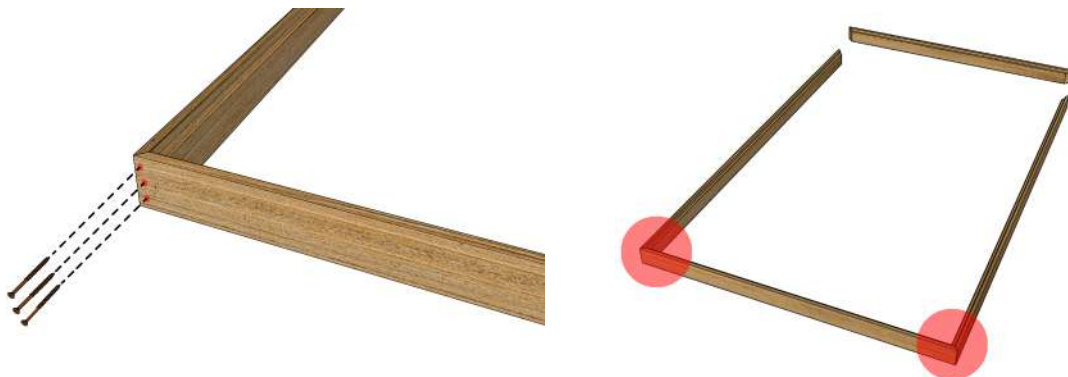
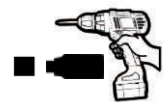

Using a driver & Robertson screwdriver bit fasten the corner of the frame with 3 screws.  
Do the same for the opposite corner.



## BUILDING THE BOTTOM FRAME

3

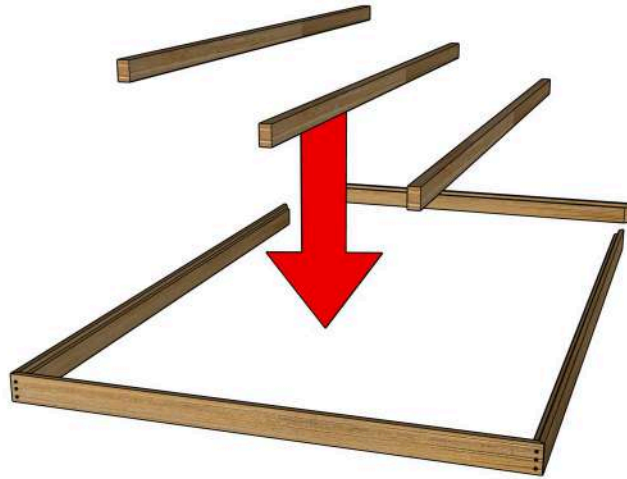

4

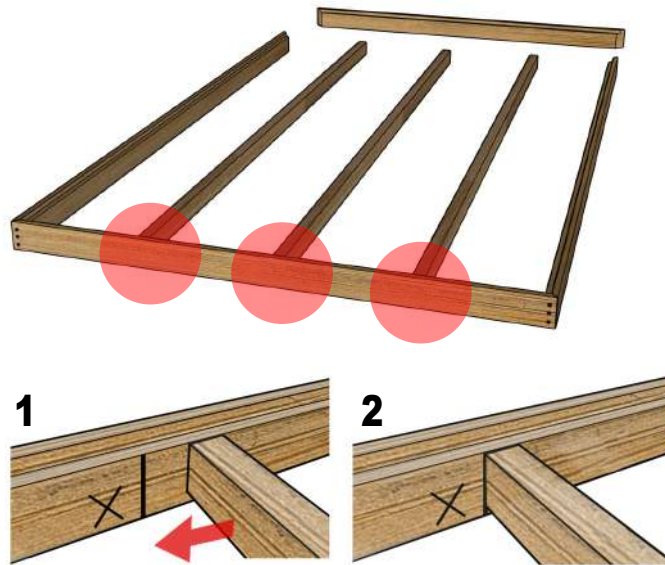

Place 3 boards on the inside of the frame. Position near the inside of the line near the X.



## BUILDING THE BOTTOM FRAME

5

 **9X**  
3" Robertson

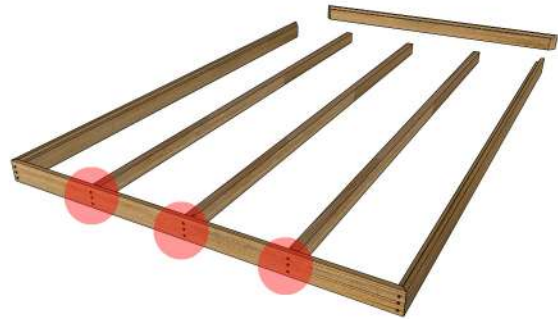
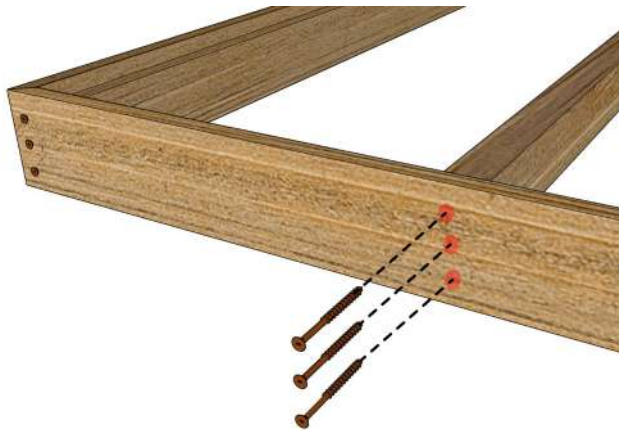
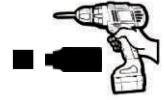

Using a driver & Robertson screwdriver bit fasten the three staves with 3 screws on each stave.

6

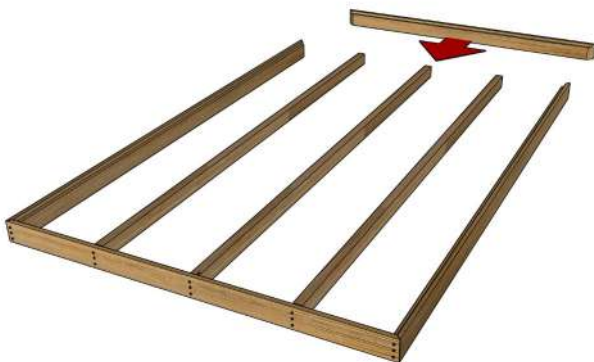

Place the 4th board on the open corners of the frame.



# BUILDING THE BOTTOM FRAME

7

 **15X**  
3" Robertson

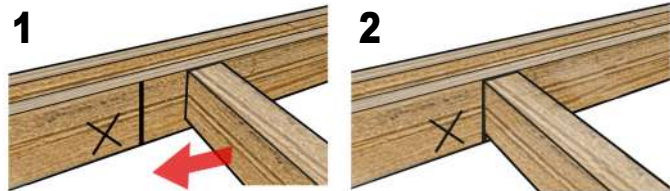
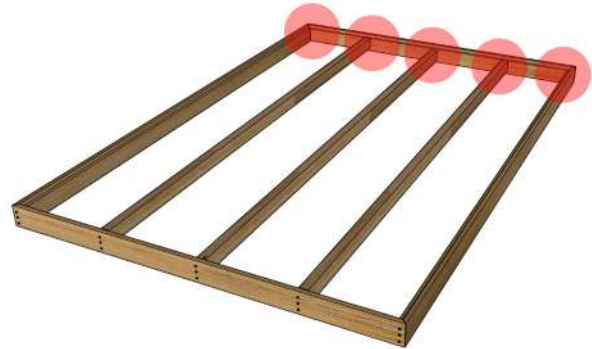
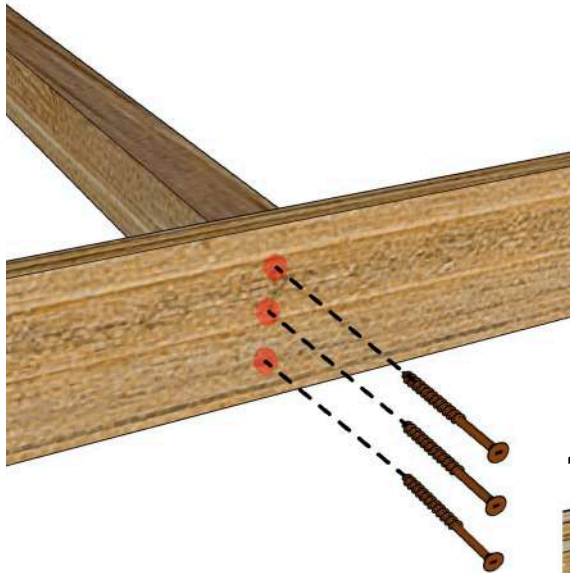
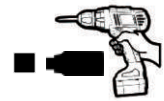

Using a driver & Robertson screwdriver bit fasten all areas shown above with 3 screws on each stave. Ensure that the inside staves are positioned and aligned with the X position (See above).

8



Ensure frame is perfectly square



## BUILDING THE BOTTOM FRAME

9



Slide and place a temporary board in the centre of the frame.  
This will help keep the side joists in place.

10

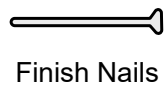

Finish Nails

OR



Staples

1 1/4"

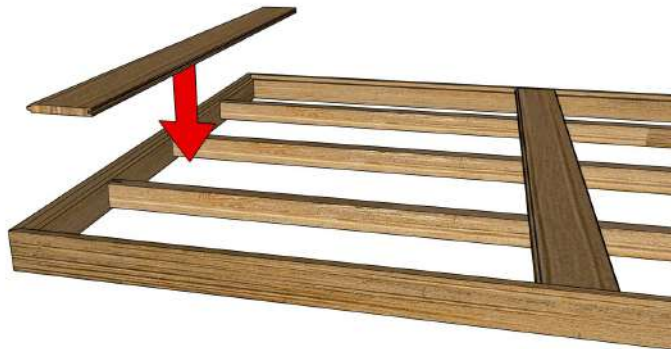

Starting at the end of the frame place the floor boards into the groove of the frame. Ensure the tongues are tight into the grooves. Secure each board with staples or finish nails.  
See **Image B** for areas to nail.



## BUILDING THE BOTTOM FRAME

11

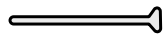

Finish Nails

OR



Staples

1 1/4"



Continue positioning and securing added floor boards. Ensure the tongues are tight into the grooves. Secure each board with staples or finish nails in the areas shown in **Step 10**.  
PLEASE NOTE: Leave the last floor board unnailed.

12

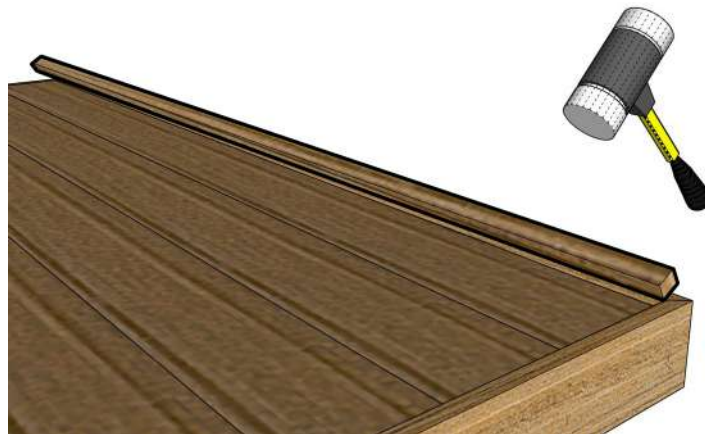
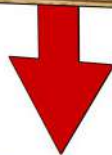

After continuing to the end of the frame with the floor boards you will have a smaller space than will allow for a regular sized floor board. Add a small finisher board. Position the finisher board into the allowed space. After the finisher board is in place nail the two final boards.



## BACK WALL section

13

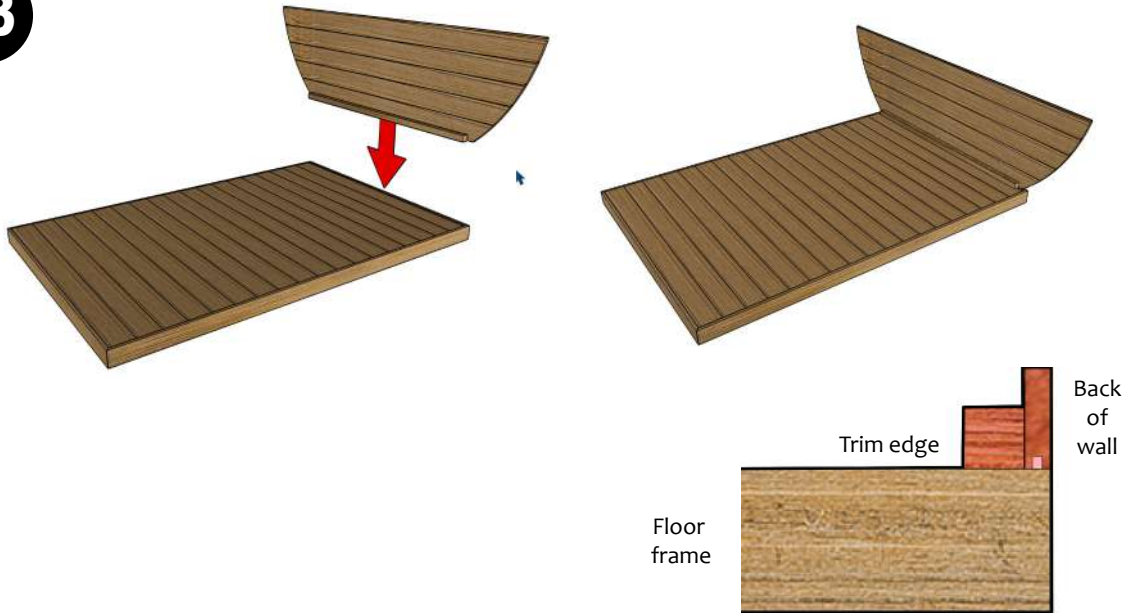

Place the wall section near the back of the floor frame. Ensure the trim edge of the section is facing the inside of the floor frame and the opposite side is flush with edge of the floor frame.

14

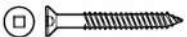
 **5X**  
2 1/2" Robertson

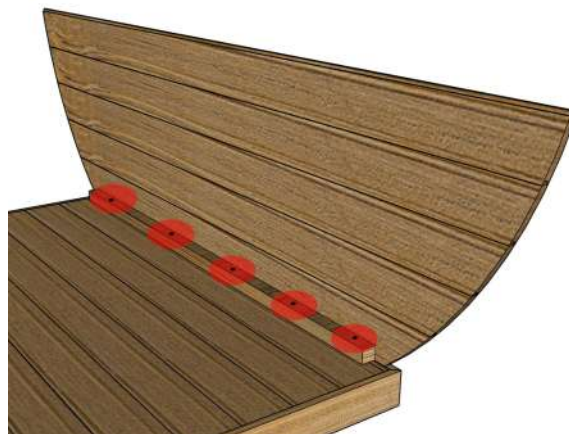
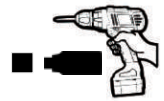

Secure the back wall with 5 screws evenly spaced on the trim edge. See image above.



## SIDE WALL section

15

 **5X**  
2 1/2" Robertson

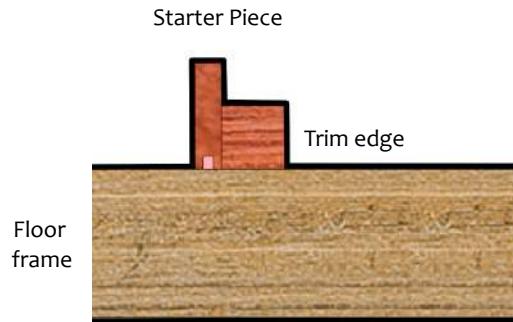
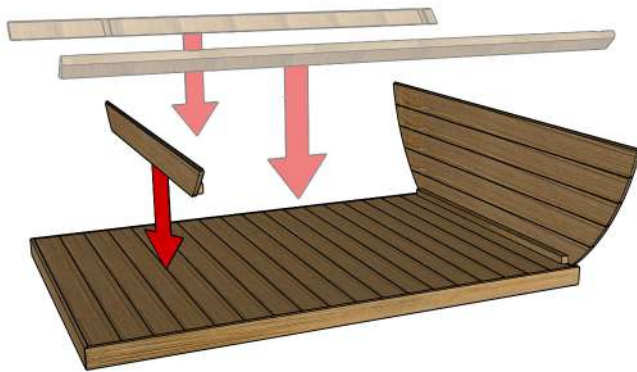
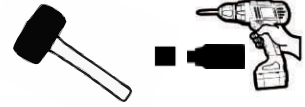

Temporary place 2 staves to get the correct placement of the front wall. Place the front wall starter piece. Ensure the starter piece trim edge is facing to the inside of the floor frame (see above).

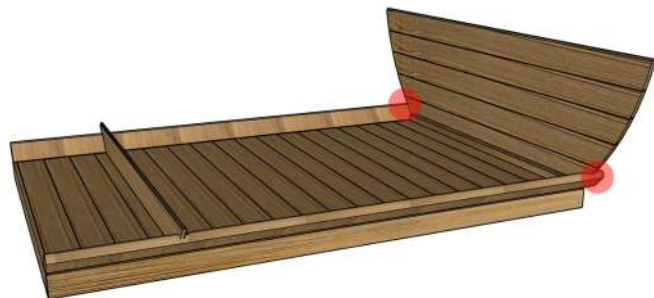

Fasten the connection between the staves and the back wall.



Scan the code for a video of the assembly process:



## FRONT WALL section

**16**  **5X**  
2 1/2" Robertson

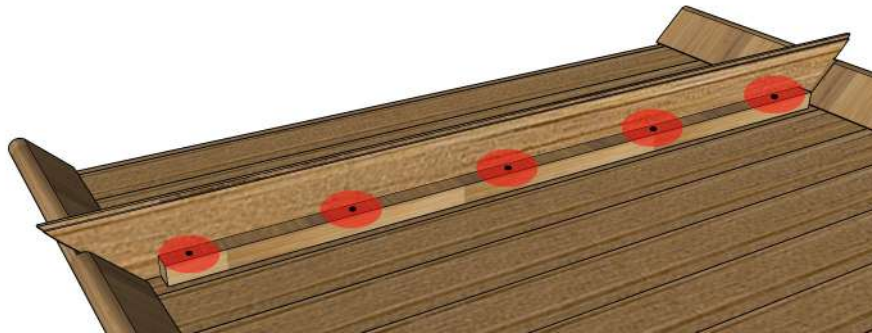
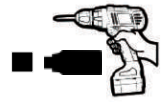

Fasten the starter piece with screws in the pre-drilled holes.

**17**

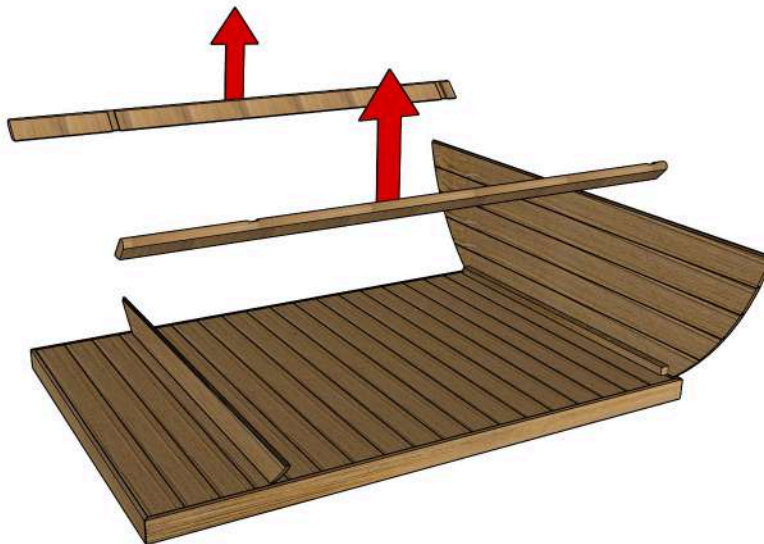

Unfasten and remove the temporary staves.



## FRONT WALL section

18

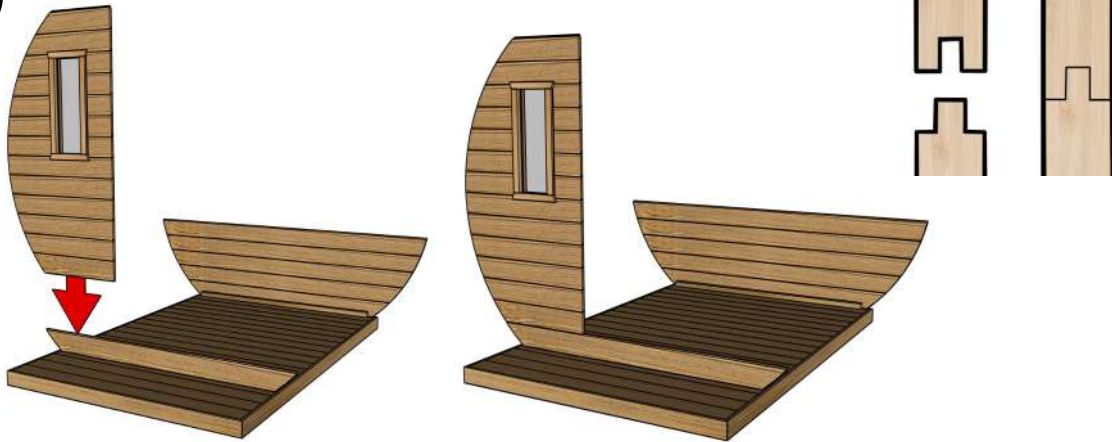

Place the first door section unto the front starter section. Ensure the door section is sitting on the groove of the starter piece.

19

 **2X**  
2 1/2" Robertson

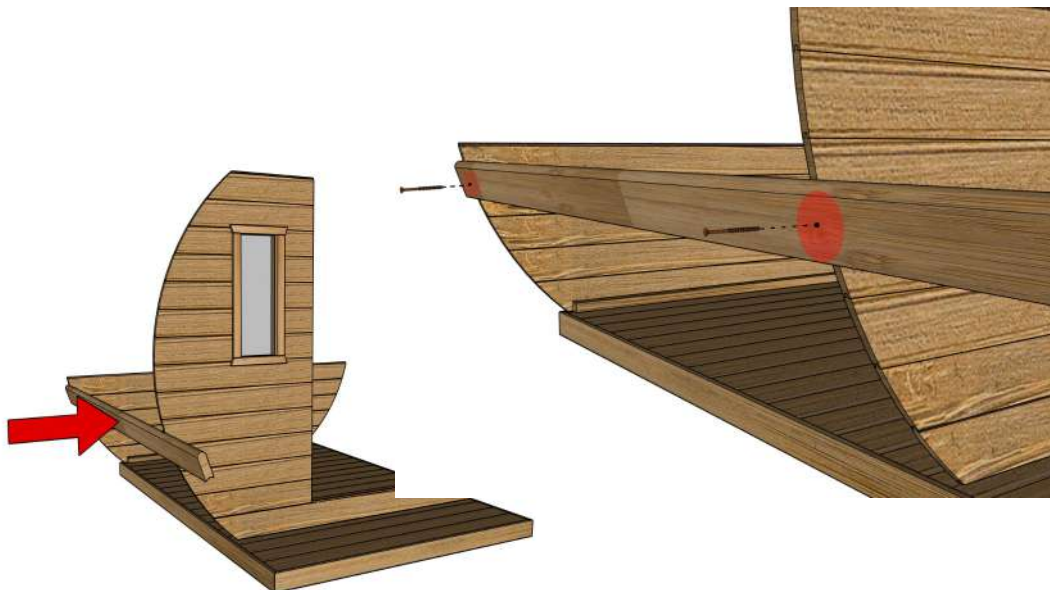
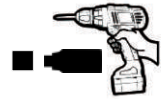

Connect and secure a temporary stave to the front and back section wall with a screw.



## FRONT WALL section

20

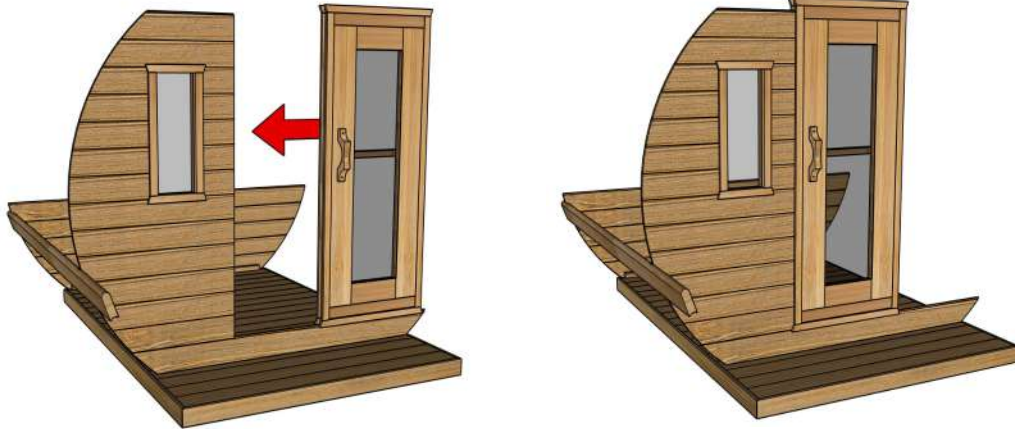

Place the first door in place against the front section. You may need a mallet to snug the door against the wall section. Ensure the wall is tight in the groove and the door hinges are facing to the outside of the frame.

\*\*\*SIDE NOTE FOR DOOR SWING PREFERENCE\*\*\*

21

 **2X**  
2 1/2" Robertson

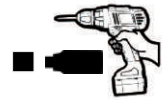

Place the second door section onto the front starter section. Ensure the door section is sitting on the groove of the starter piece and snug against the door.



## BACK WALL section

22

 **2X**  
2 1/2" Robertson

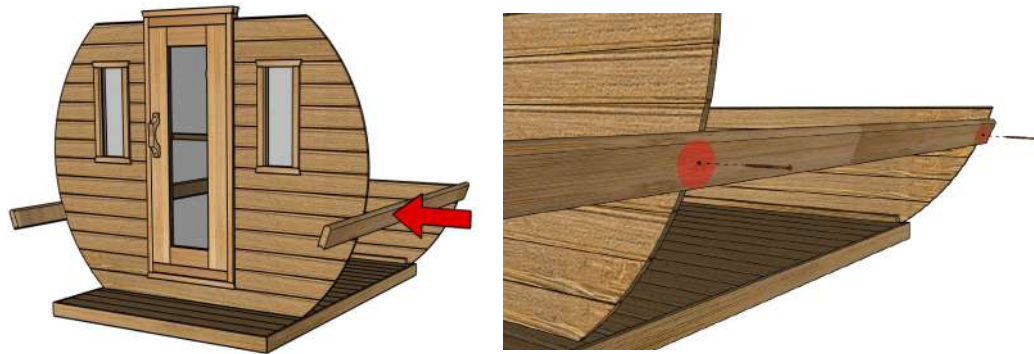
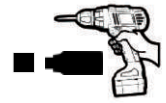

Connect and secure a temporary stave to the front and back section wall with a screw.

23

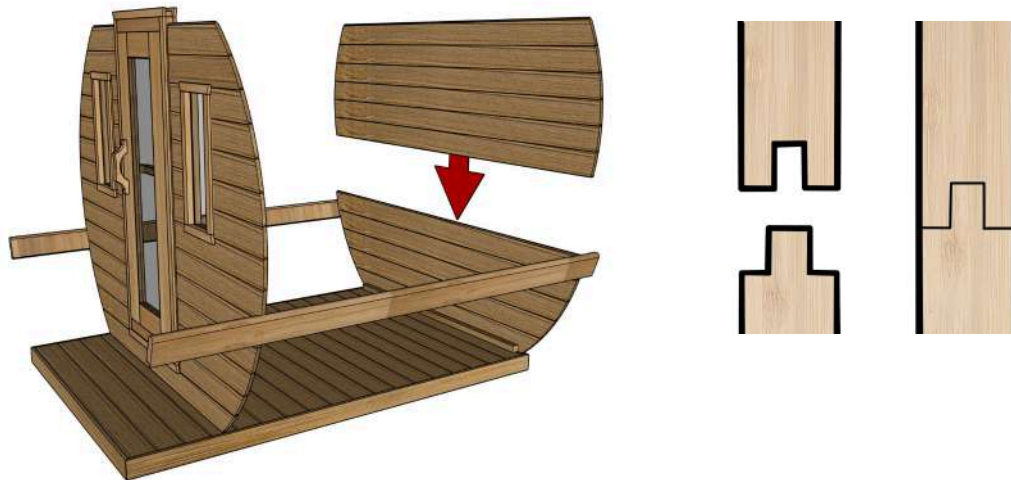

Place the next wall section onto the back wall. Ensure it is tightly on the groove of the back wall.



## SIDE WALL section

24

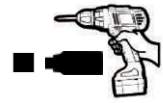
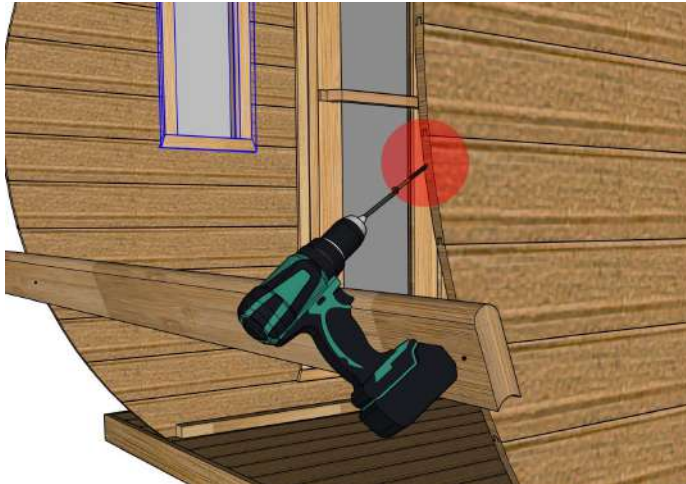

Fasten and secure the top section of the back wall to the bottom section with a screw on both sides.

25

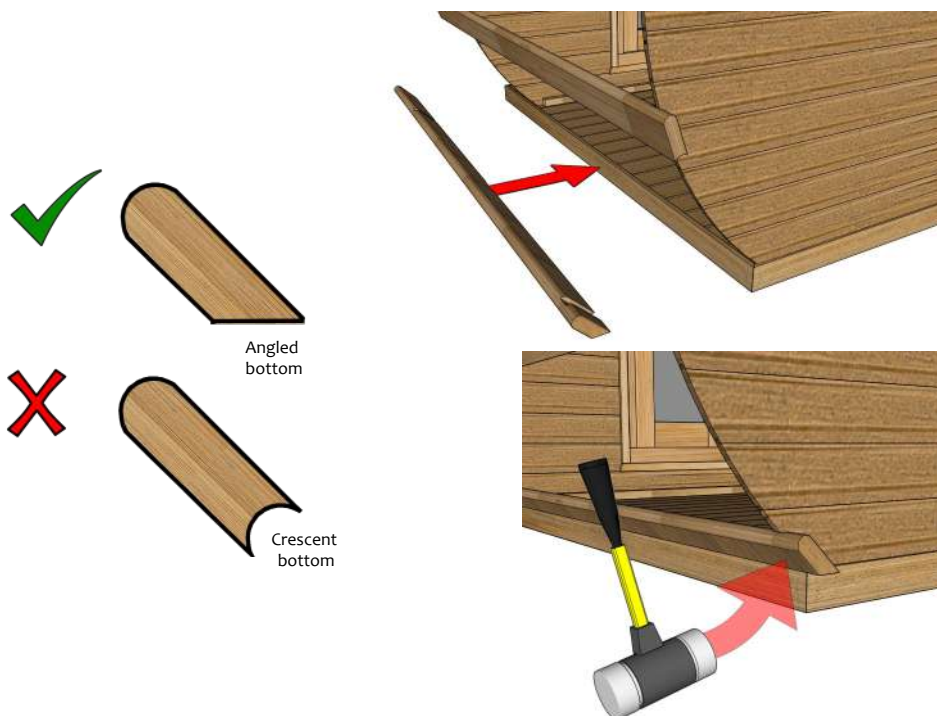

Connect the angled stave onto the front and back wall section. Use a mallet if necessary to tap each side and ensure a tight fit between the stave and the wall sections.



## SIDE WALL section

26

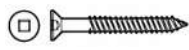
 **2X**  
2 1/2" Robertson

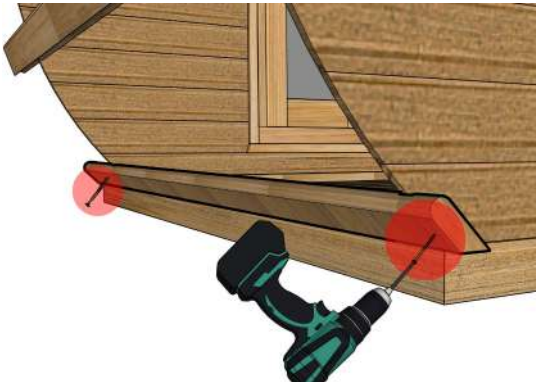
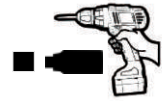

Fasten the angled stave onto the front and back wall section. Use a mallet if necessary to ensure a tight fit between the stave and the wall sections.

27

 **7X**  
2 1/2" Robertson

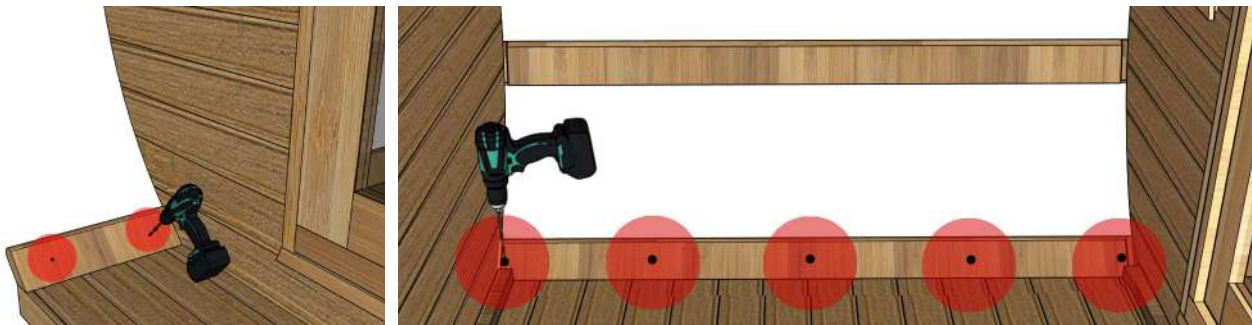
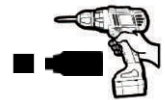

Sauna Outside Area

Sauna Interior

Continue fastening the stave to the frame using the 7 pre-drilled holes.(See image above).



## SIDE WALL section

29

 **2X**  
2 1/2" Robertson

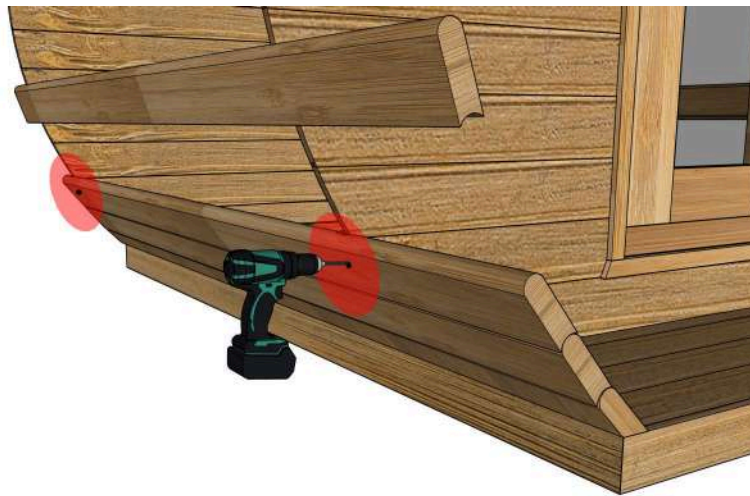
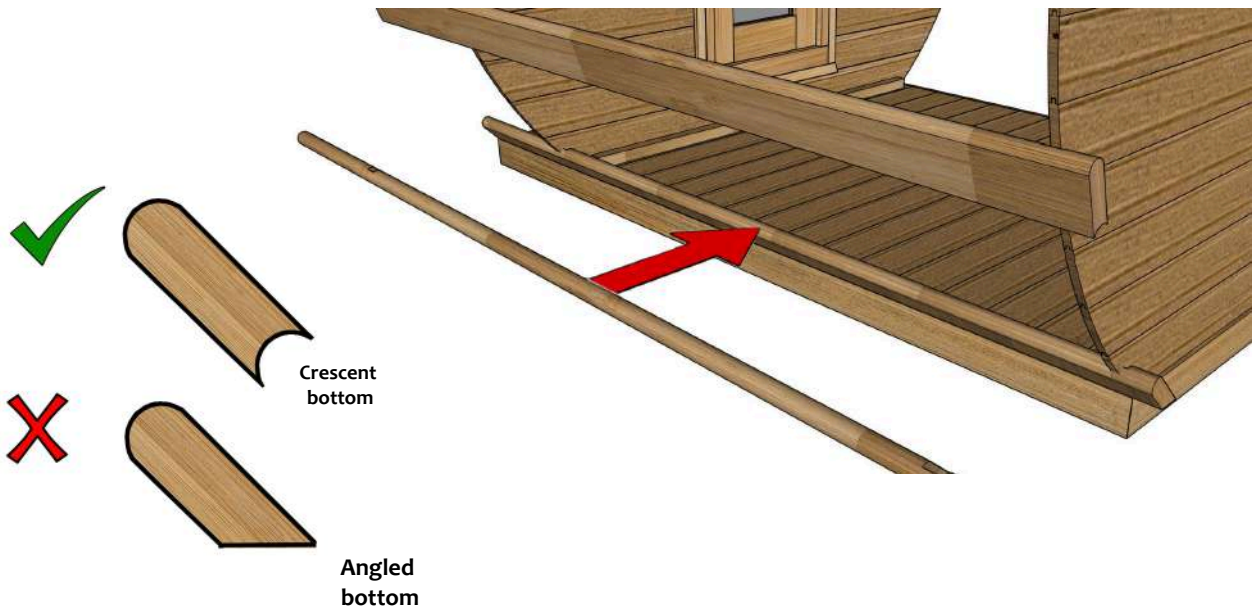

Continue adding staves. Fasten the stave to the front and back wall section  
Using 1 screw in the pre-drilled hole at each end of the stave.



## SIDE WALL section

30

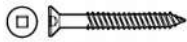

2 1/2" Robertson

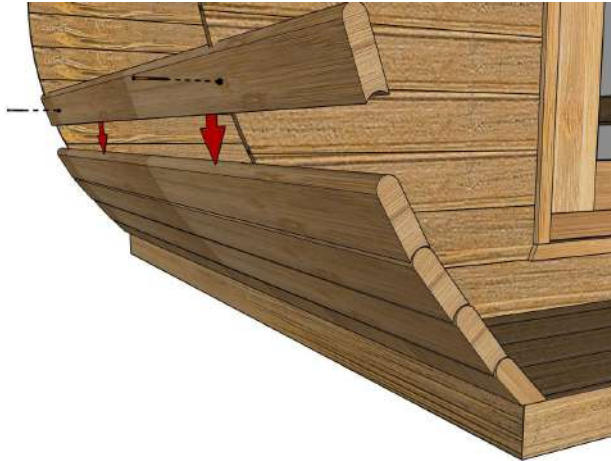
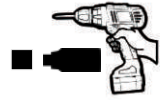

As you continue placing and fastening staves you will eventually come to the temporary stave that was set to hold the front and back sections. Unscrew this stave. Place the stave so it is firmly connected to the stave below it. Fasten the stave to the front and back wall section using the existing screws in the pre-drilled hole at each end of the stave.

31

Follow **Steps 26-30** for the opposite side of the sauna frame.

32

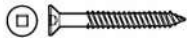

2 1/2" Robertson

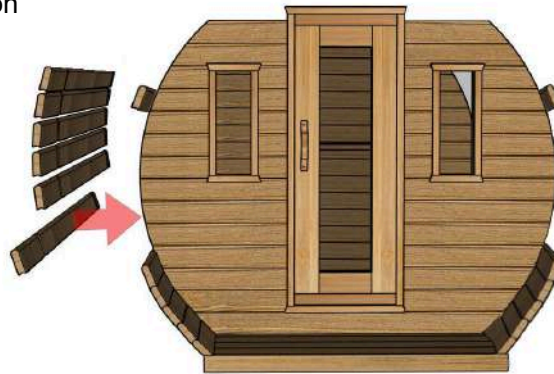
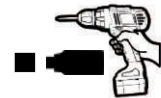

Continue to place and fasten staves until you get to the halfway point of the sauna frame. As you continue placing and fastening staves you will eventually come to the second temporary stave that was set to hold the front and back sections. Unscrew this stave. Place the stave so it is firmly connected to the stave below it. Fasten the stave to the front and back wall section using the existing screws in the pre-drilled hole at each end of the stave.



## SIDE WALL section

**33**

Follow **Step 32** for installing the staves on the opposite side of the sauna frame.

**34**

 **2X**  
2 1/2" Robertson

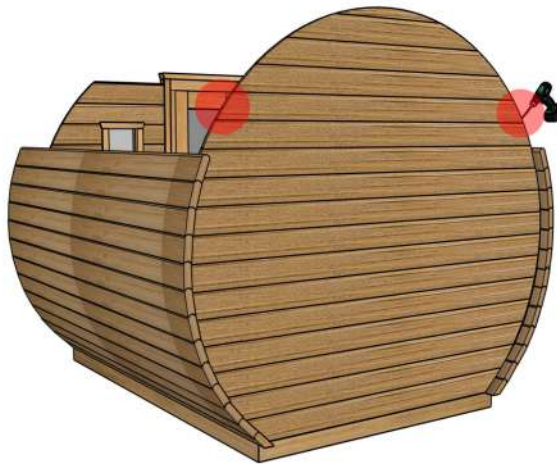
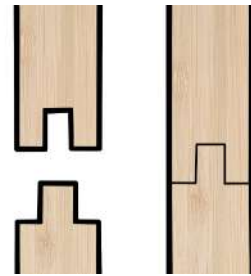
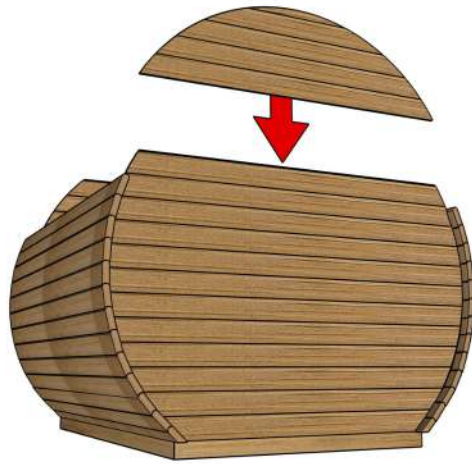
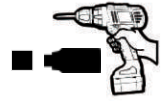

Position the top tier for the back wall section of the sauna frame. Ensure the section bottom is snug inside the groove of the stave below.



## SIDE WALL section

35

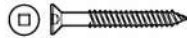
  
2 1/2" Robertson

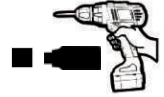

Position and fasten additional staves until you have reached the line where another tier section must be added to the front section.

36

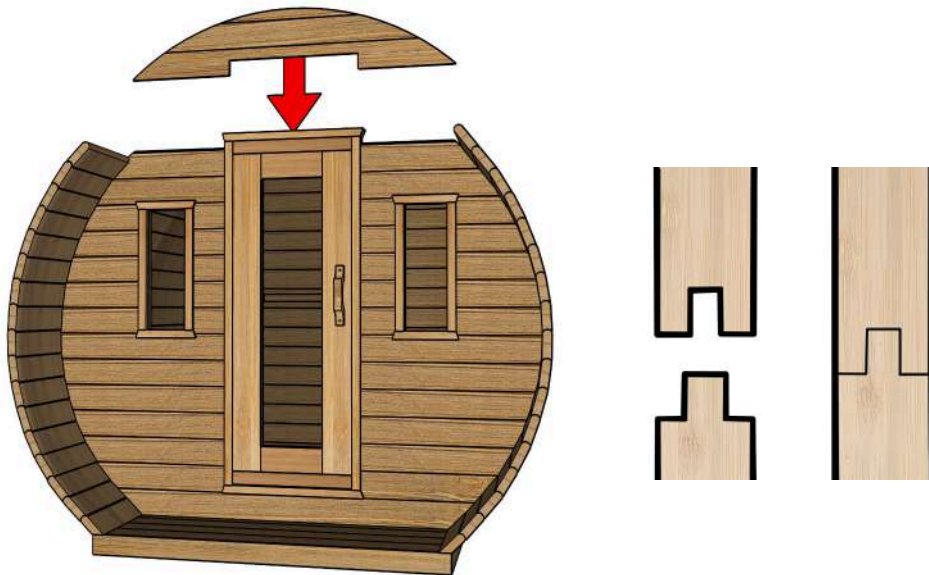

Position the top tier for the front wall section on the sauna frame. Ensure the section bottom is snug inside the groove of the stave below.



## SIDE WALL section

37

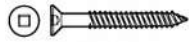

2 1/2" Robertson

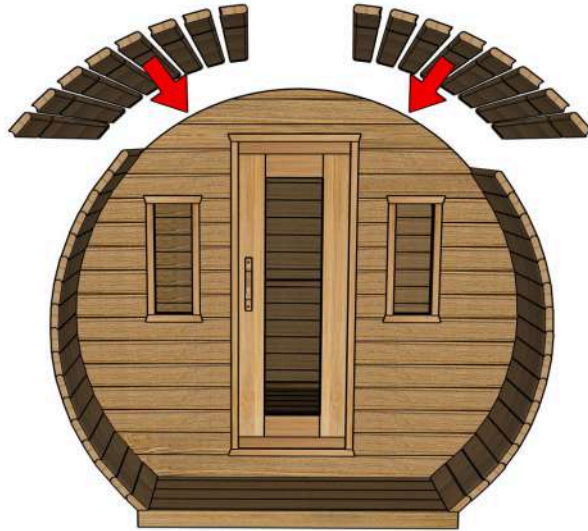
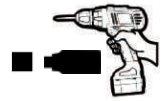

Finisher  
Stave

Position and fasten additional staves in equal numbers on both sides of the sauna frame. When you have finished and there is only enough room for one more stave in the centre add the finisher stave that has a cup shape at both ends (See above).

38

Step continued next page

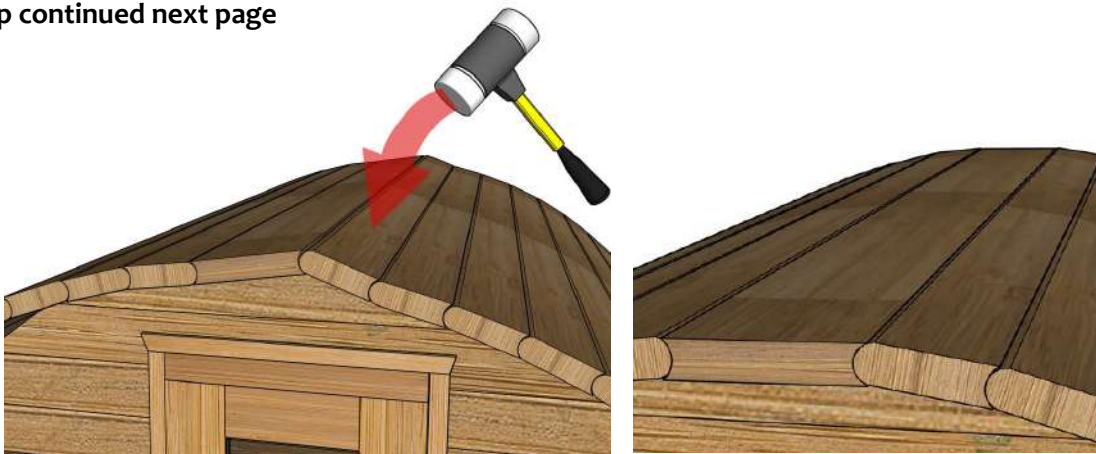

When the finisher stave has been fitted into place it may be tight making it necessary to use a mallet to relax some staves so the finisher stave can be put snug into position.



## SIDE WALL section

39

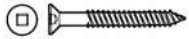
 2 1/2" Robertson

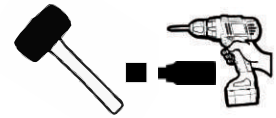

Continued from last page



It may be difficult to fit the finisher stave into place so it may be necessary to unscrew some staves to make room for the finisher stave. Loosen any necessary staves below the finisher stave on either side. With a mallet tap out and down until the finisher fits nicely and all the wall boards are tight together and rounded. Secure all loose boards and the finisher board.

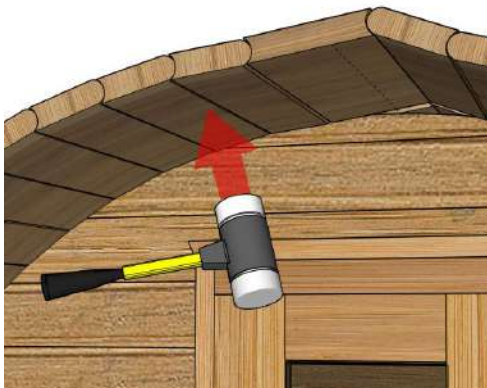

## DOOR section

40



Place the outer door handle at desired height.

41



Ensure it is centred and secure with screws.

42

2 1/2" Robertson



43

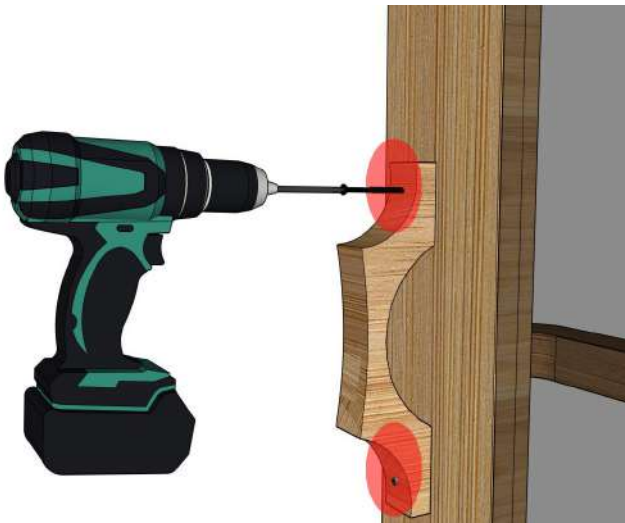

Fasten with 2 screws.



Place the inner door handle at the same height as the outer door handle.



## DOOR section

44

 **2X**  
2 1/2" Robertson

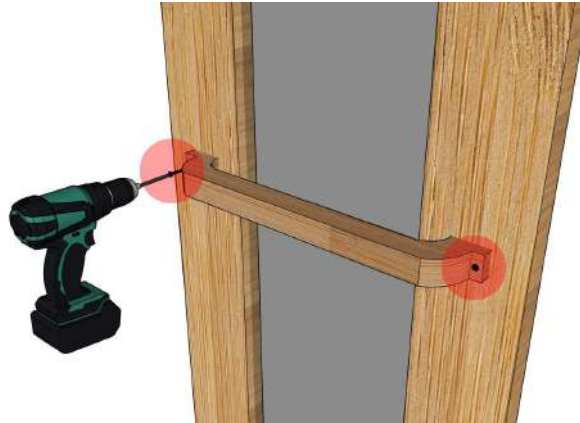
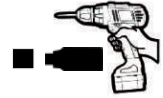

Fasten with 2 screws.

45

 **1 1/4"**  
Staples

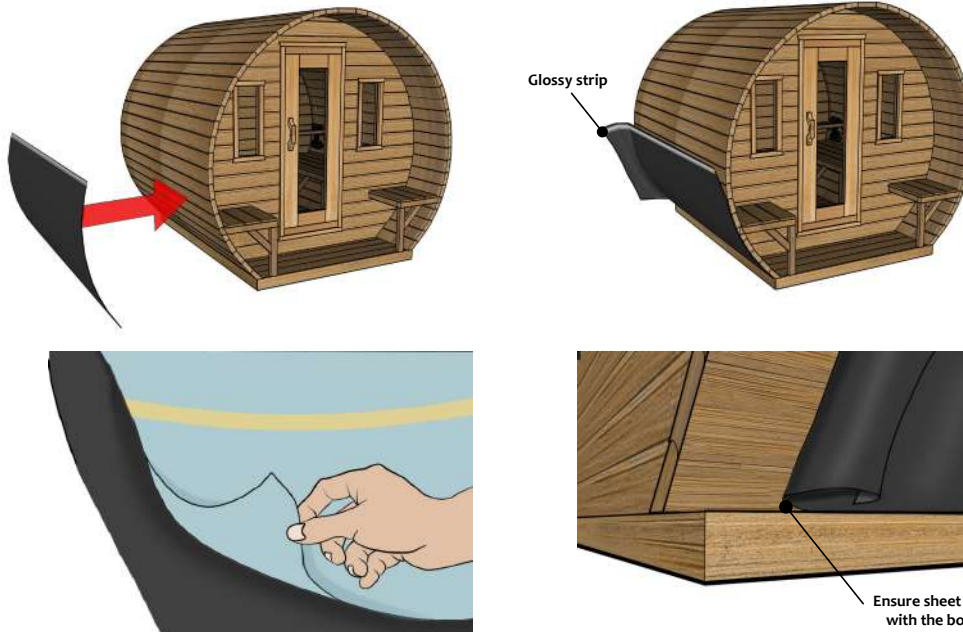

Peel the film off of the sheet of ice and water shield. Make sure it is aligned with the bottom of the starter wall board and sauna frame. The glossy strip should be on top.



Scan the code for a video of the assembly process:



## ICE SHIELD section

46

 1 1/4"  
Staples

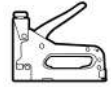

Secure the sheathing with staples to the sauna frame.

47

 1 1/4"  
Staples

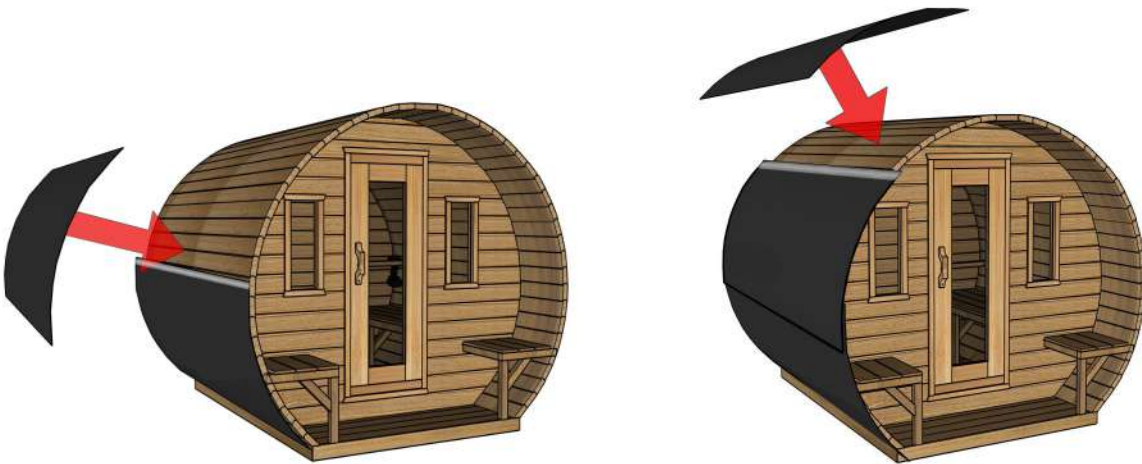
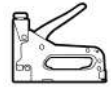

Add the second sheet and third sheet of ice and water shield. Ensure the bottom overlaps the glossy strip of the previous sheet.



## ICE SHIELD section

48

 1 1/4"  
Staples

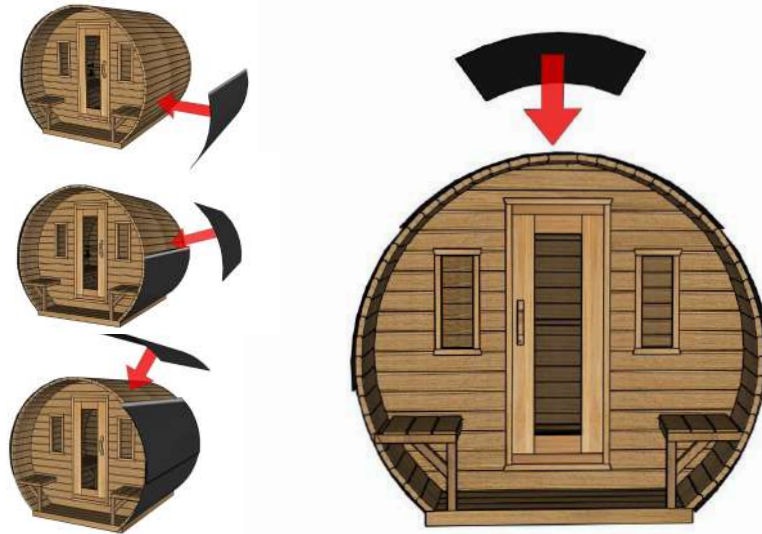
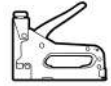

Repeat **Steps 45-47** adding three more sheets to the opposite side of the sauna frame. Add a final sheet on the top of the sauna frame that covers the sheeting on both sides.

49

 1 1/4"  
Staples

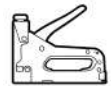

Fold the ends of the ice and water sheeting over and staple the ends of the side wall board to the sheeting. Repeat **Step 49** for the back of the sauna frame.



## ICE SHIELD section

50



Using a utility knife cut the excess sheeting off both the front and back of the sauna frame.

51

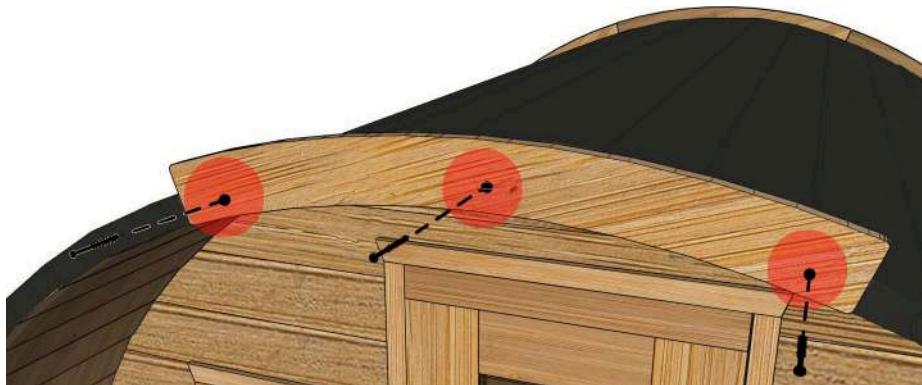

Position the first piece of trim to the front of the sauna frame. Fasten with three screws.



## SHINGLE section

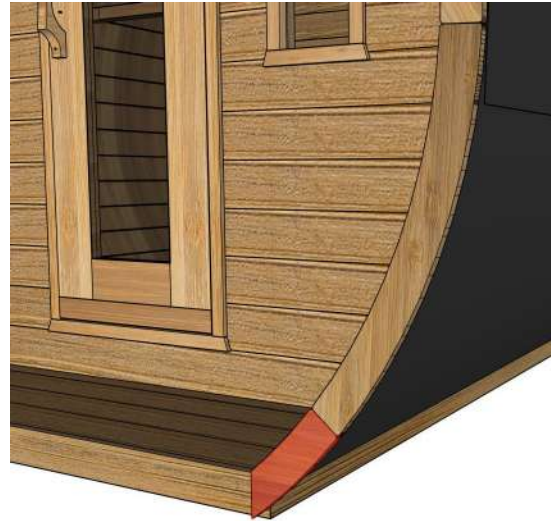
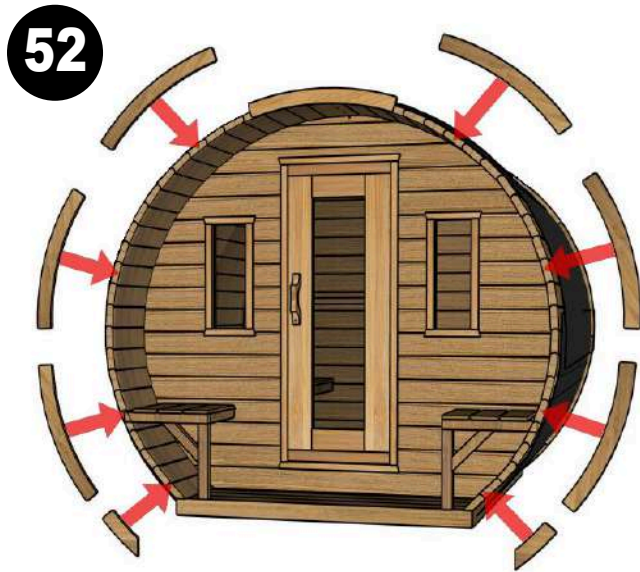

Continue placing and fastening the rest of the trim pieces. Fasten each trim piece with three screws. The smallest pieces will be for the bottom. After the front of the sauna frame is finished follow **Steps 51-52** for the backwall of the sauna.

**53** Finish Nails  or 1 1/4" 

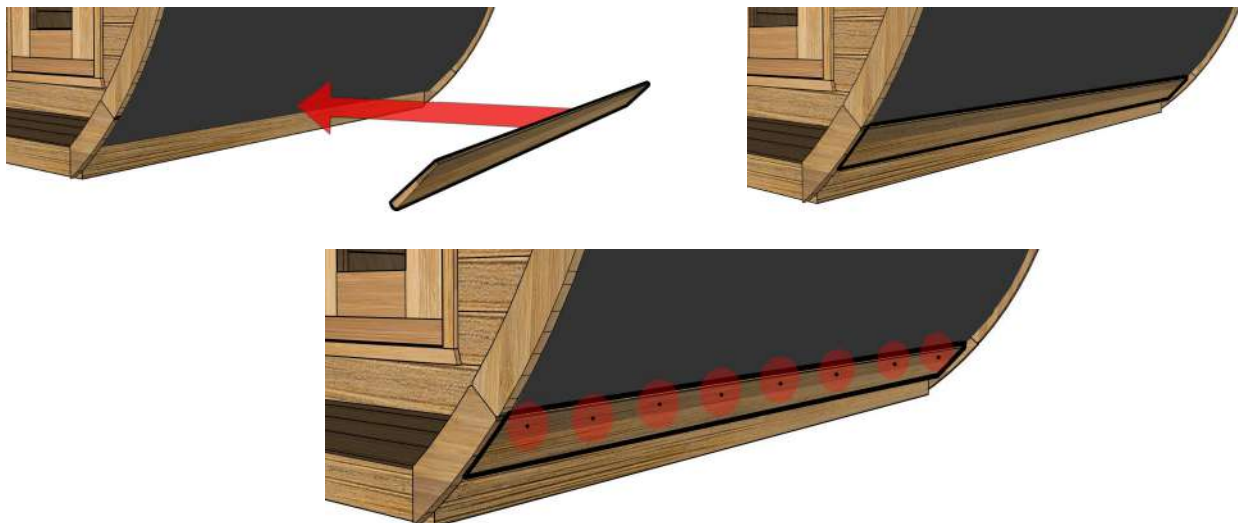



Begin placing the siding boards. Ensure each piece is flush with the sauna frame. Secure with finish nails or staples across the top.



## SHINGLE section

54

Finish Nails  or 1 1/4" 

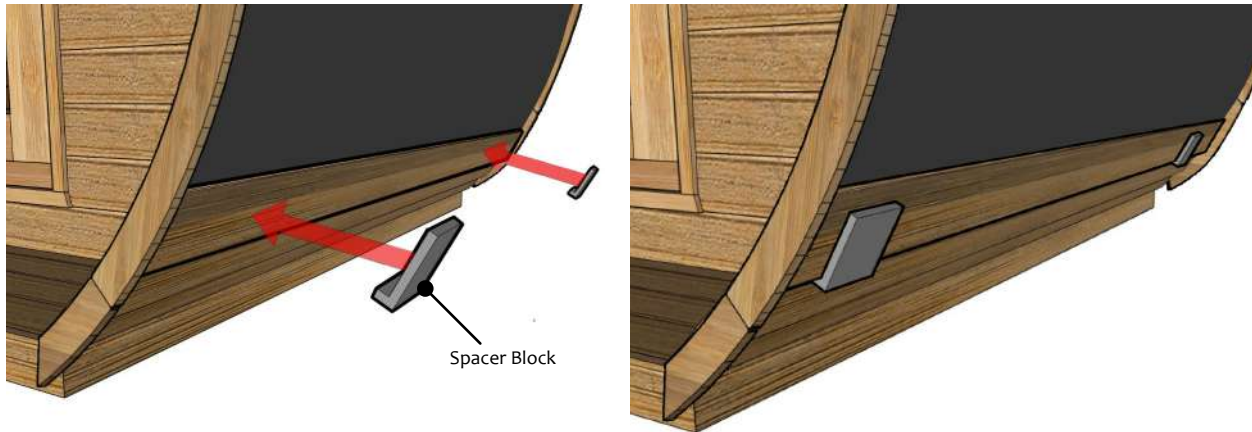
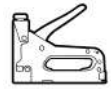

Use the provided spacer blocks to gauge the correct distance for spacing between each board. Position the spacer block underneath the last installed shingle. Do this for both sides of the board.

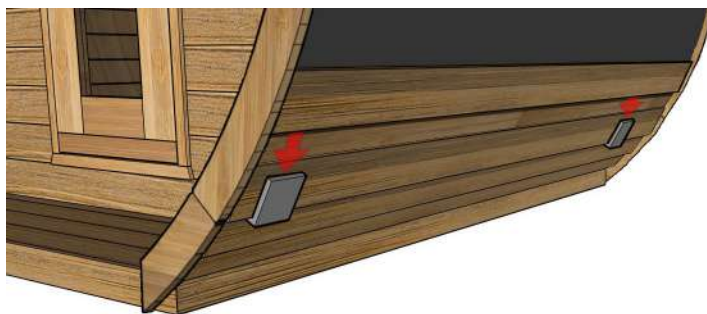

Slide the next shingle on top of the spacer block for both ends. This will determine where the shingle will be fastened. Continue adding shingles using this method. Secure with Finish nails or staples across the top.



Scan the code for a video of the assembly process:



## BENCH section

55

 **3X**  
2 1/2" Robertson

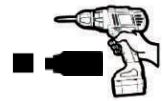

**A**

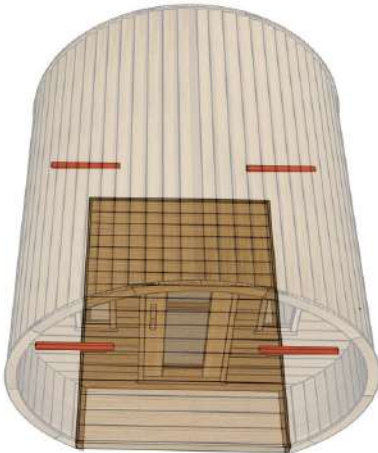

**B**

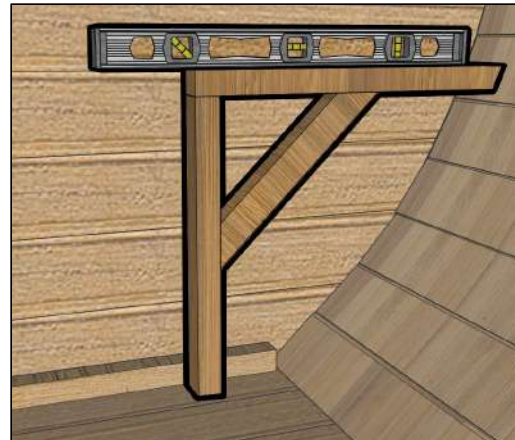

**A.** Inside the sauna place a large bench support along the back and front of both sides of the sauna enclosure. **B.** Ensure the large bench supports are level.

**C**



After leveling each bench position mark all 4 spots with a pencil.

**D**



Position a small bench support under the marked line and fasten the support with three screws. Do this for all four areas.



## BENCH section

56

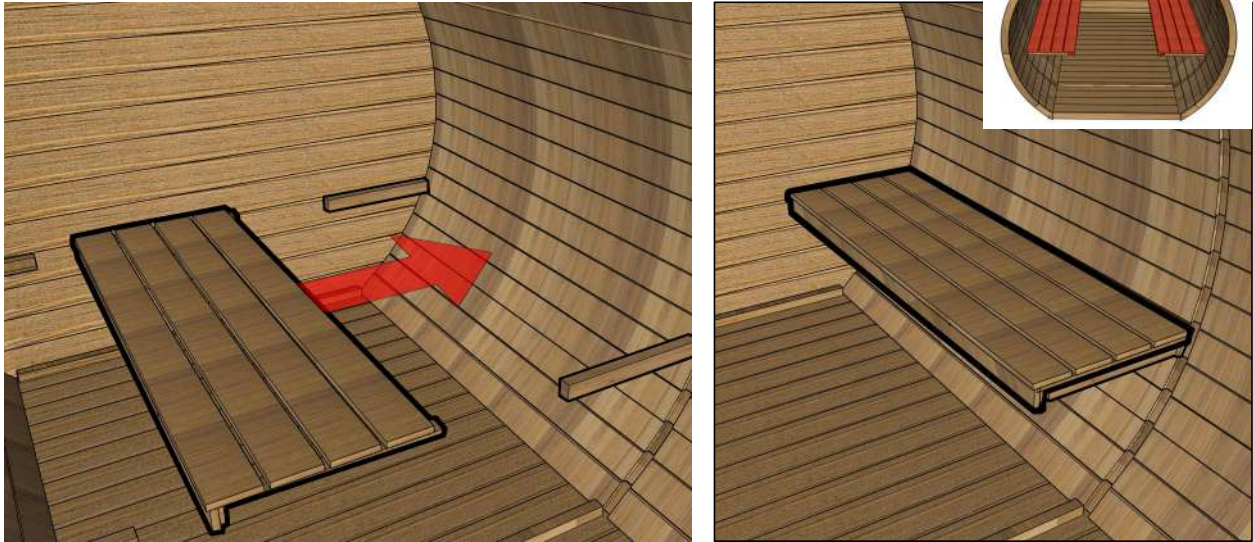

Place the bench flat onto the bench supports. Repeat **Step 56** for the second bench.

57



Position the large bench supports underneath the bench flat. Align with the cross beams on the bench flats. Follow **Step 57** for all four large bench supports.



## BENCH section

58

 **4X**  
1 1/2" Robertson

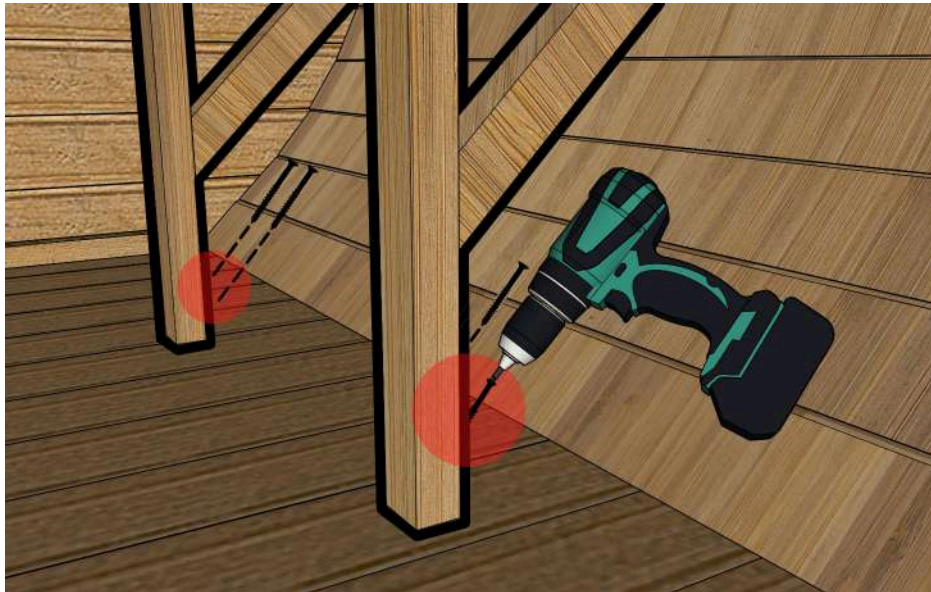
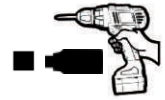

Fasten the legs of the large bench supports with screws in pre-drilled holes.  
Follow **STEP 58** for all large bench supports on both benches.

59

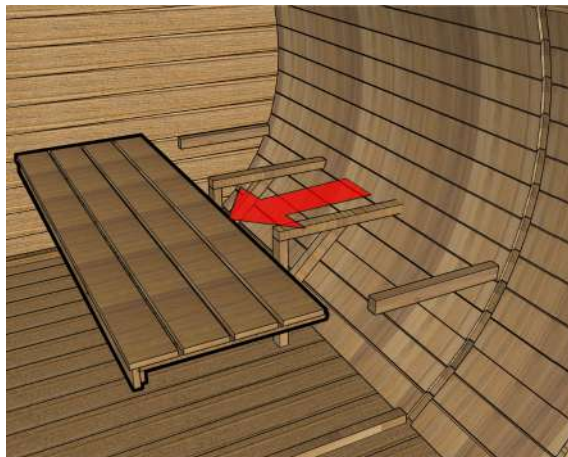

Temporarily remove the bench flats to gain access to the large bench supports.  
Follow **STEP 59** for both benches.



## BENCH section

60

 **8X**  
1 1/2" Robertson

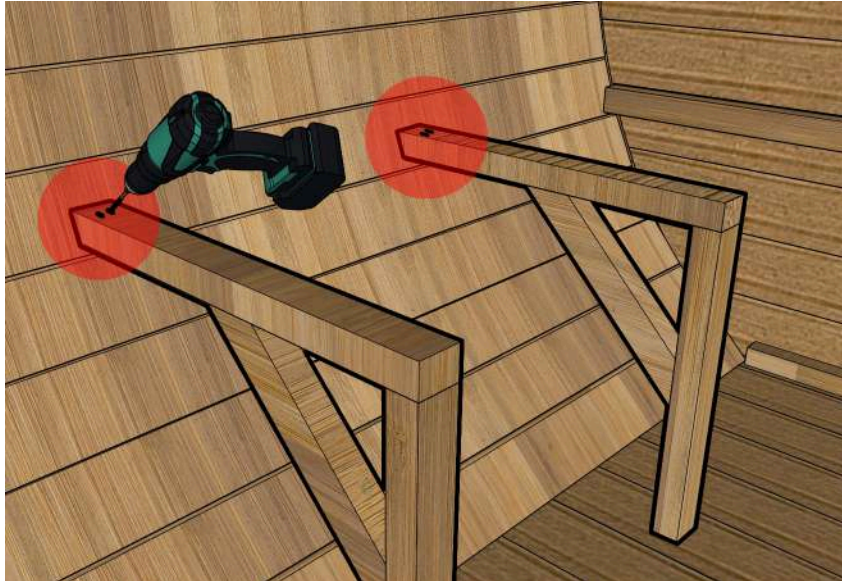
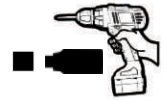

Fasten the large bench support with two screws each. Repeat **STEP 60** for supports on each bench.

61

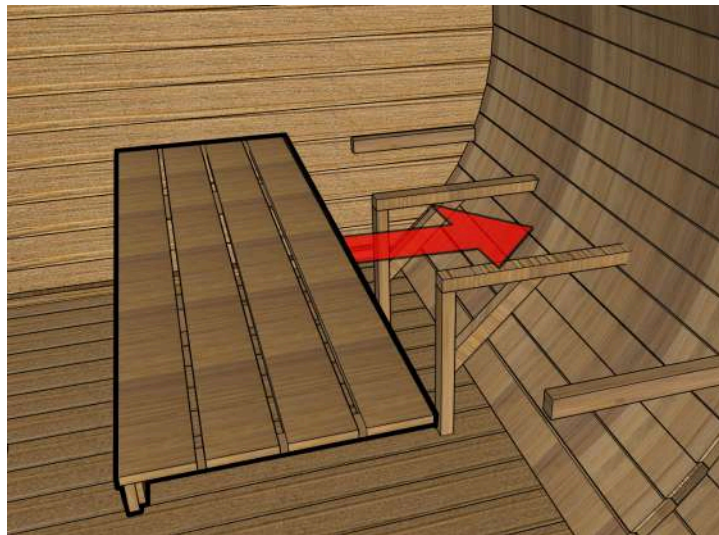

Place the bench flats onto the bench supports. Repeat **Step 61** for the second bench.



## BENCH section

62

 **10X**  
1 1/2" Robertson

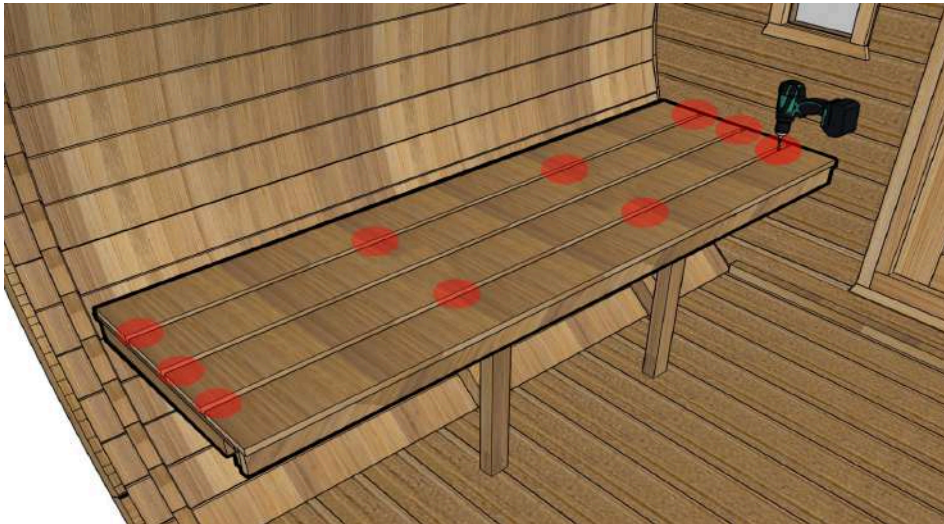
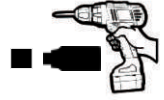

63

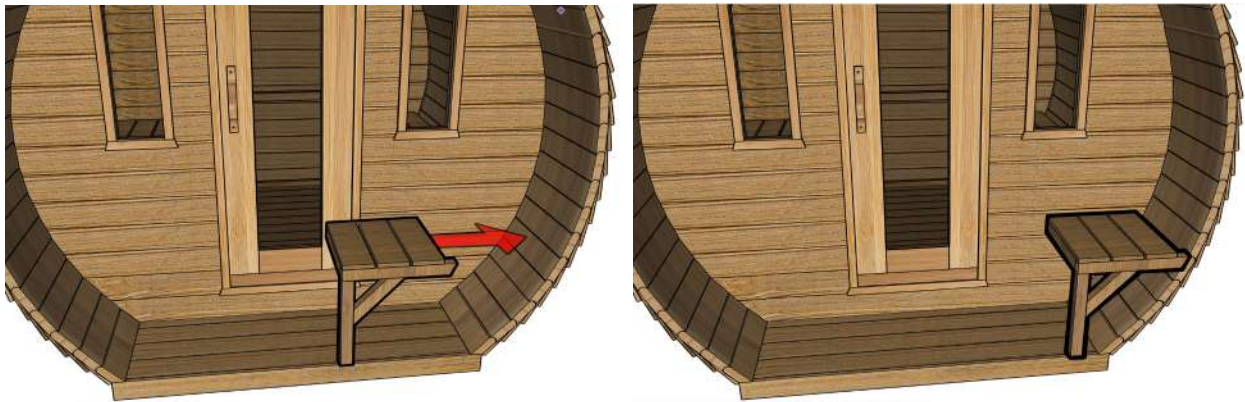

Place the outside bench on the side of the barrel.

**PLEASE NOTE:** Some elements have been removed to better illustrate assembly.



## BENCH section

64

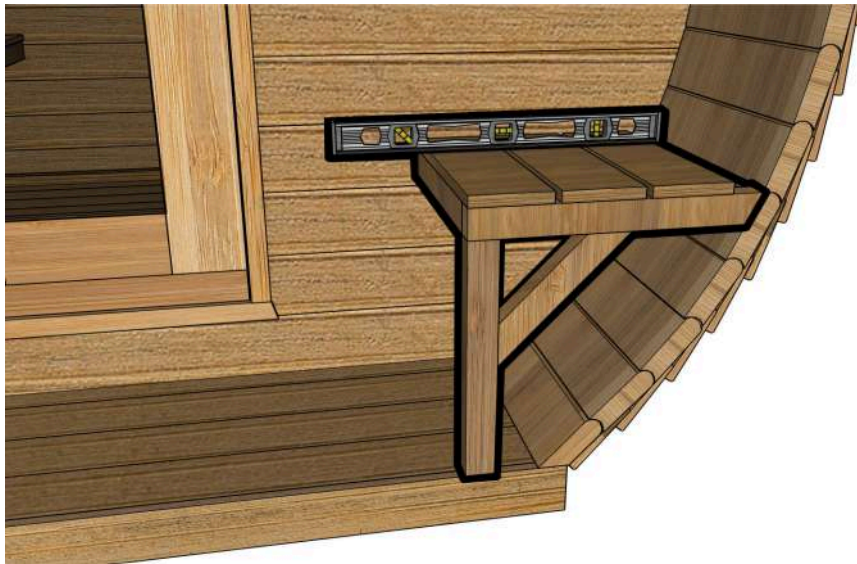

Ensure the bench is placed in a level position.

**PLEASE NOTE:** Some elements have been removed to better illustrate assembly.

65

  **4X**  
2 1/2" Robertson

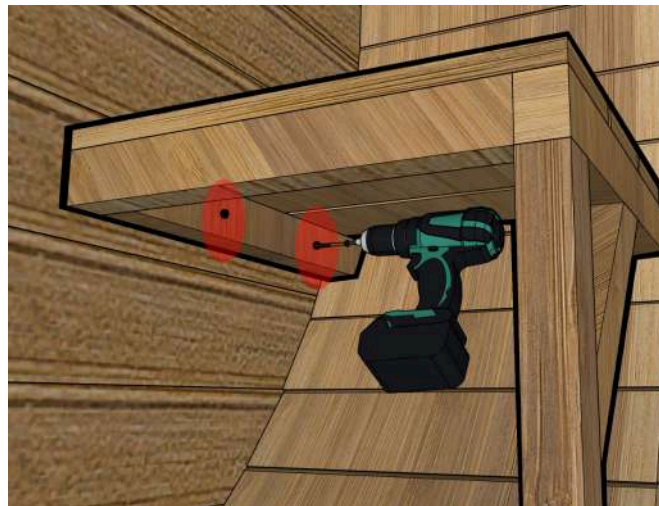
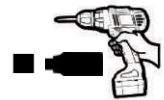

Fasten the outside bench to the front wall with screws in the pre-drilled holes.

**PLEASE NOTE:** Some elements have been removed to better illustrate assembly.



## BENCH section

66

 **4X**  
2 1/2" Robertson

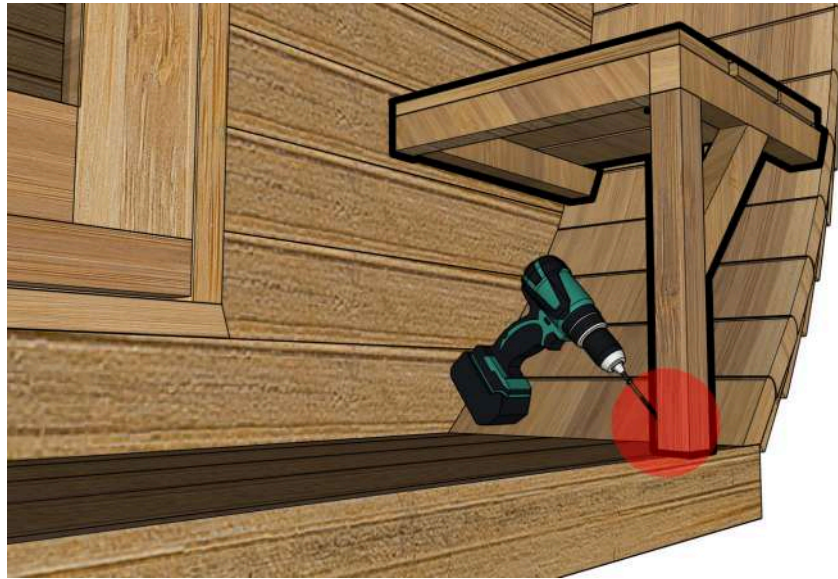
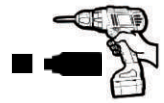

Fasten the outside bench to the sauna floor with screws in the pre-drilled holes.  
**PLEASE NOTE:** Some elements have been removed to better illustrate assembly.

67



Repeat **STEPS 63-66** for the second outside bench.



Scan the code for a video of the assembly process:



## DOOR section

68

 **2X**  
2 1/2" Robertson

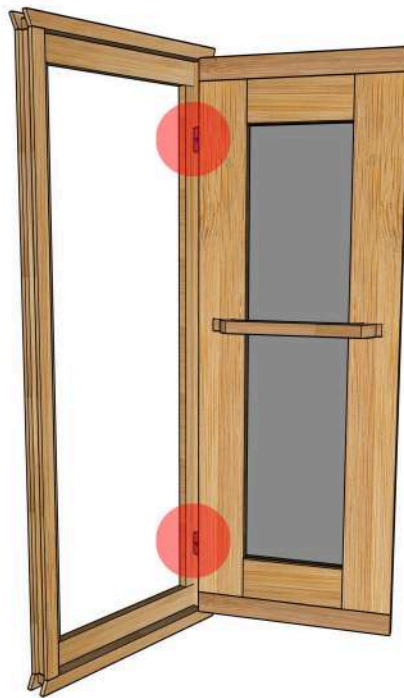
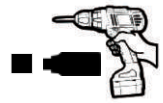

Secure the door frame at the front wall with 2 screws through the open hole on both hinges.



## VENT section

69



Position the vent cover on the upper front wall on the inside of the sauna.

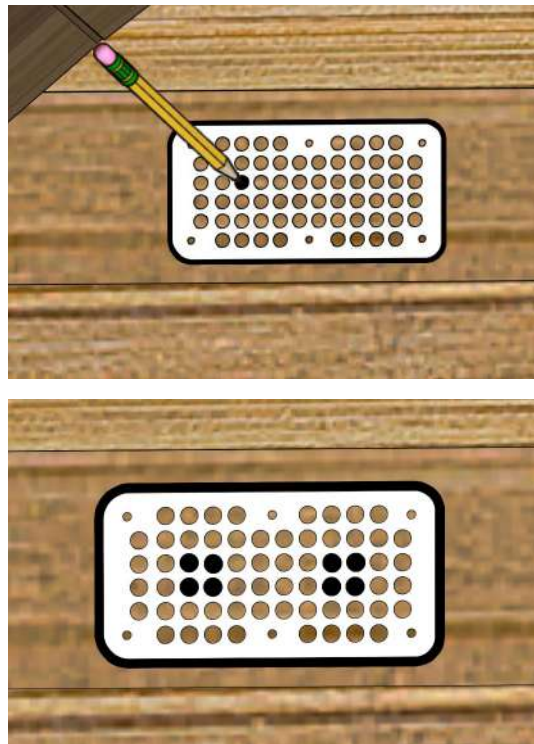

Using the vent cover as a template mark off the dots as shown with a pencil.



## VENT section

70

2" Hole Saw Recommended  
1 1/2" Minimum

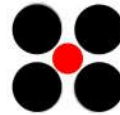
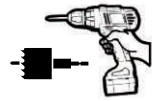

Remove the vent cover and use a two inch hole saw to add two holes side by side for the vent. Add each hole between the four pencil marks etched on the wall from **Step 69**.  
**PLEASE NOTE:** Only drill half way through the wall to avoid splintering the wood.

71

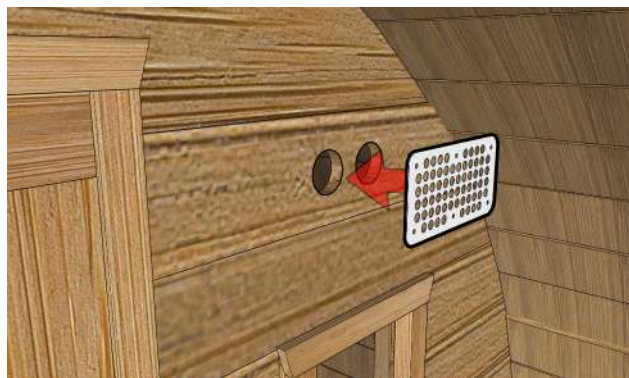

Continue drilling out the holes from the outer wall of the sauna.  
On the outer wall of the sauna position the vent cover over the two holes.



## VENT section

72

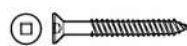
 **6X**  
Provided screws

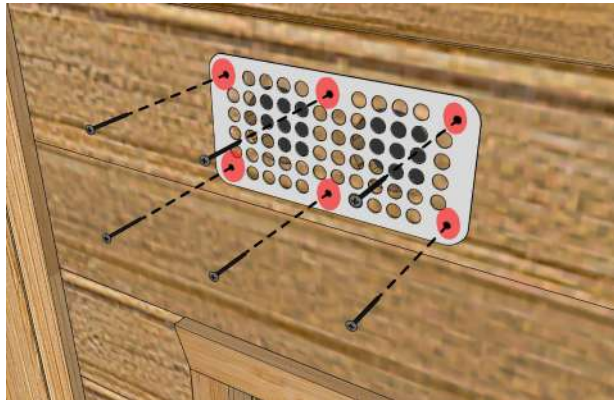
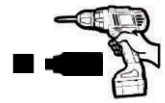

Fasten the vent cover on the outside wall with the six provided screws.

73

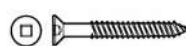
 **1X**  
1 1/2" Robertson

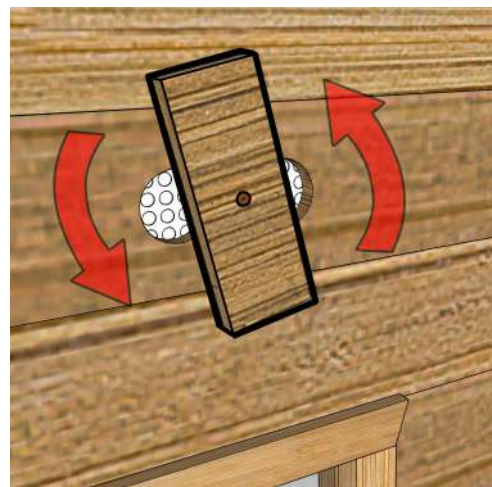
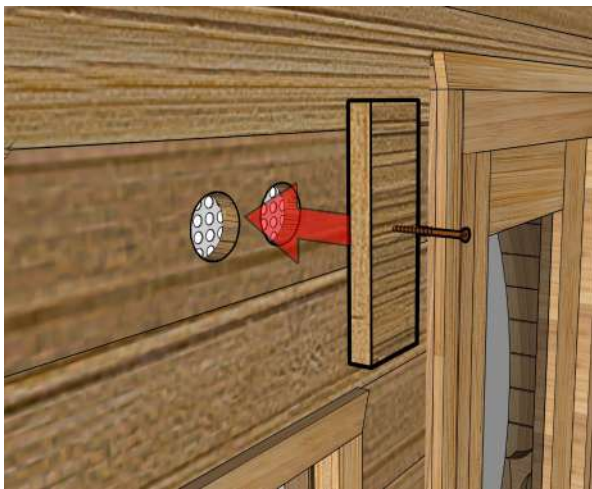
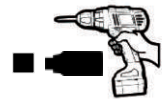

Add a screw to the provided wooden block in the pre-drilled hole.

Position and fasten the block between the two cut-out holes.

**Please Note:** Only tighten the wooden block enough that it may swivel firmly



## VENT section

74



From the inside of the sauna repeat the process shown in **STEPS 69-73** on the back wall of the sauna below a bench.

That concludes the basic instructions for the  
**Canadian Timber Elation Sauna.**

If you have any accessories left to install or will be in the near future please continue on to the next section.

We hope you enjoy your sauna.



# ACCESSORY Install section

## Thermometer (Optional)

 **1X**

Nail



Place thermometer in desired location and secure with the provided nail.

## Sand Timer (Optional)

 **2X**

2 1/2" Robertson

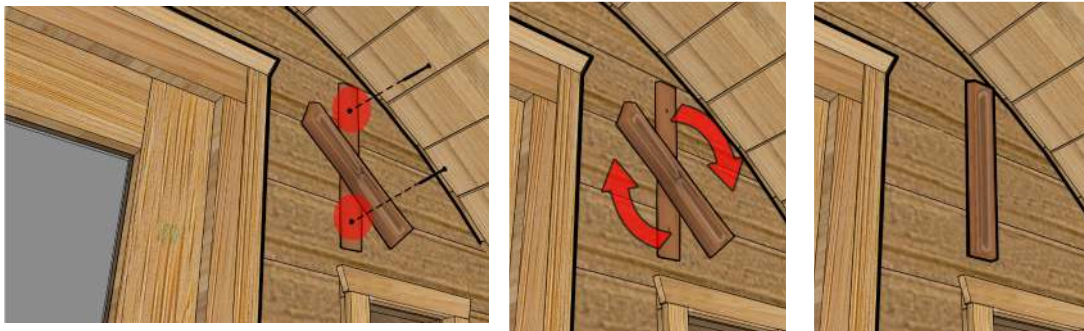
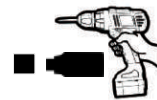

# ACCESSORY Install section

## Shelf (Optional)

 **2X**  
2 1/2" Robertson

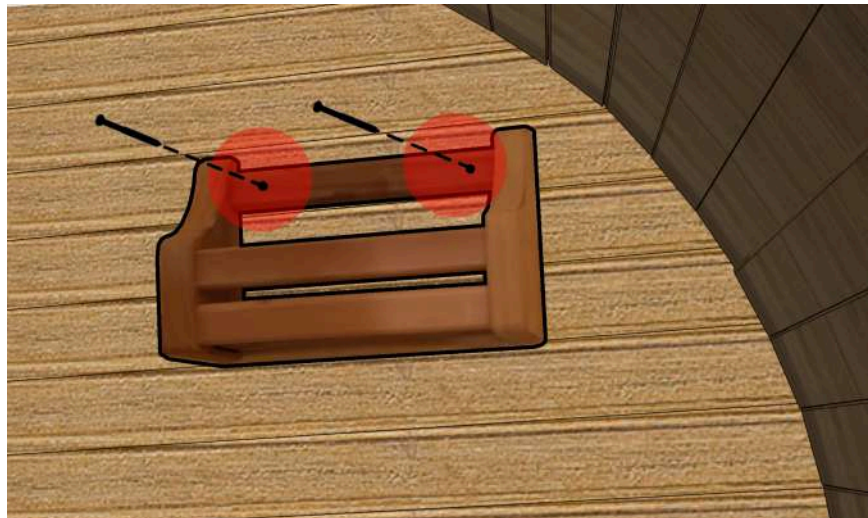
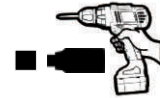

Place the towel hook in desired location and secure with screws in the pre-drilled holes.

## Towel Hook (Optional)

 **4X**  
2 1/2" Robertson

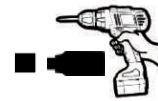

Place the towel hook in desired location and secure with screws in the pre-drilled holes.



# INTRODUCING OUR SAUNA STAINS & FINISHES



## ALIS NATURAL OIL FOR EXTERIOR WOOD

Perfect for your sauna and garden furniture. This protective oil for outdoor wood offers great value.



Sesame



Light Teak



Elm Dark Brown



Black



## MELDOS NATURAL OIL FOR SAUNA INTERIORS

Meldos is a natural and versatile impregnating, perfect for protecting soft Woods and ideal use in saunas.

See your local paint retailer to purchase your preferred outdoor stains or water sealer or you can try LIVOS wood care products from Leisurecraft today!



Scan the code for a video of the assembly process:



# Maintaining Your Sauna After Installation

## INTERIOR

It is recommended to vacuum or sweep out the inside of your sauna frequently to remove dirt and debris. Under normal conditions, a slight wash of the floor and benches with warm soapy water several times a year will maintain its cleanliness. Leisurecraft offers a sauna room cleaner that can be used pure or diluted at a 4-1 ratio. Simply spray and wipe!

You can use a sheet of fine grit sandpaper or a low-pressure wash to remove more stubborn stains for a deeper cleaning of the interior of your sauna.

**NEVER USE ammonia or harsh cleaners as they can turn the wood gray.**



## EXTERIOR

Depending on the humidity and weather conditions in your area, the cedar will either shrink or expand based on the amount of moisture absorption. The desired effect is to have the cedar expand into the bands therefore making the sauna staves much tighter. Over time the lumber will weather naturally as a result of sun and rain, it will change into a weathered grey colour. The natural weathering will not harm the wood or impair the sauna's performance.

If you wish to retain the natural color of your Leisurecraft Sauna, Leisurecraft offers cedar sauna stain in 4 amazing colors, Espresso, Limestone Trail, Onyx Gem, and Pickled White in convenient 1 gallon pails.

## WATER SEEPAGE

Some minor water seeping into the sauna is expected and normal for an outdoor sauna. If your sauna is properly installed, you should not have water dripping in, but you should expect some water seepage, especially on the top and sides of the sauna. This is due to the porous characteristics of the wood and to the ball-and-socket profile design of the staves. Water seepage will not harm the sauna. The moisture will evaporate once you turn on the heater and the sauna heats up. If the water marks are bothersome, they can be easily removed with a light sanding with 80 or 100 grit sandpaper.



Scan the code for a video of the assembly process:





## 5 Year Residential Limited Warranty Policy

All products designed and manufactured by Dundalk LeisureCraft Inc. ("LeisureCraft") are covered by a limited warranty against defects in materials and workmanship under normal residential use for a period of five (5) years, beginning on the date the product is received by the original end-user consumer.

This warranty does not apply to defects resulting from normal wear and tear, improper installation, insufficient or improper maintenance, natural weather conditions or failure to follow the manufacturer's installation, usage, or care instructions.

In the event of a valid warranty claim, LeisureCraft will provide replacement parts at no charge. However, please note that the replacement of parts will not extend the original warranty period.

This warranty is limited solely to the replacement of parts and does not cover any associated service, labor, or installation costs, all of which are expressly excluded.

For products offered by LeisureCraft that are not manufactured by LeisureCraft, please refer to the warranty policy and terms provided by the manufacturer.

## LIMITED WARRANTY

Dundalk LeisureCraft Inc. ("LeisureCraft") is committed to providing high-quality sauna heaters and accessories to our customers. To offer peace of mind, we will match the manufacturer's warranty on all eligible products purchased from us. If the manufacturer offers a warranty on the product, we will honor that warranty, ensuring the same terms, coverage, and duration.

This warranty is limited to the replacement of parts only. It does not cover any service, labor, or installation costs, which are expressly excluded.

This warranty does not apply to defects caused by normal wear and tear, improper installation, inadequate or improper maintenance, or failure to adhere to the manufacturer's installation, use, or care instructions.

All electrical connections must be made by a licensed electrician. Failure to comply with this requirement will void the warranty.

For warranty claims or inquiries, please contact LeisureCraft customer support at:  
Phone: 888-923-9813 Email: [support@leisurecraft.com](mailto:support@leisurecraft.com)

**Please ensure you fill out your warranty card!**





# Leisurecraft

— BUILDING LUXURY —



pure cübe

318448 8<sup>th</sup> Line Melancton, Ontario  
L9V 2K3 Canada

Phone: 519.923.9813  
Toll Free: 888.923.9813  
Fax: 866.458.7583

Check us on



Info@leisurecraft.com  
www.leisurecraft.com