

Front View

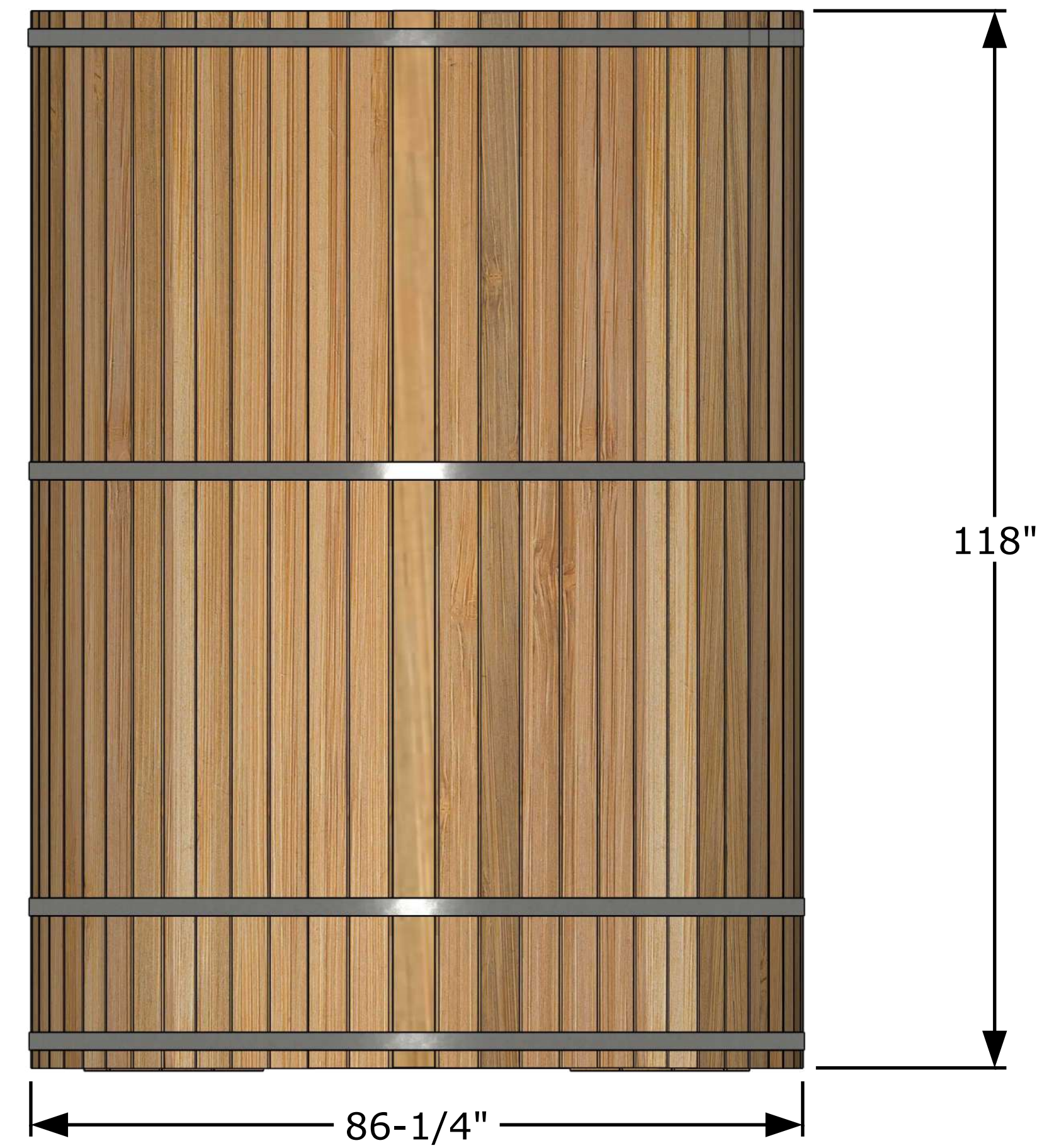

Perspective View

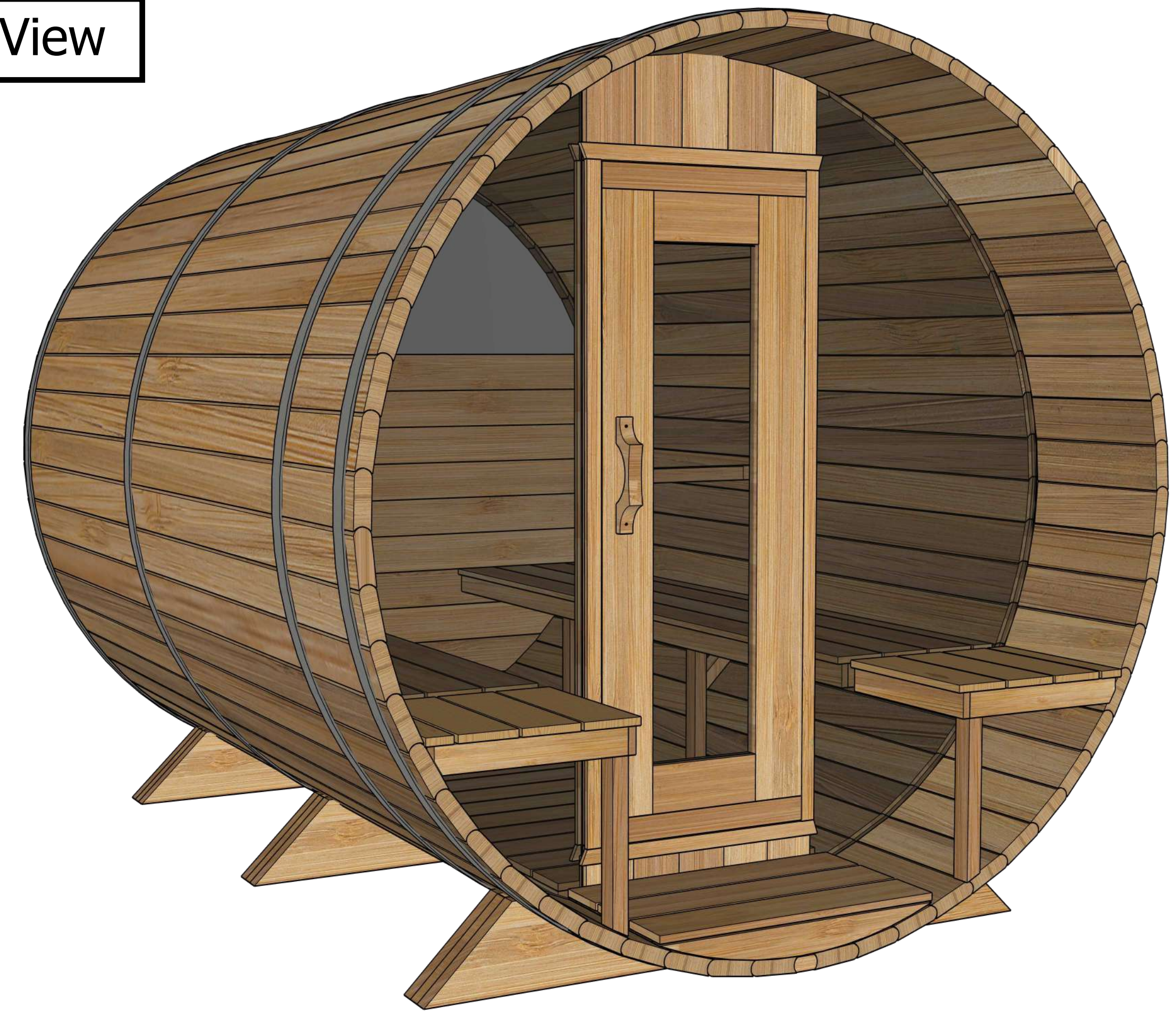

Top View

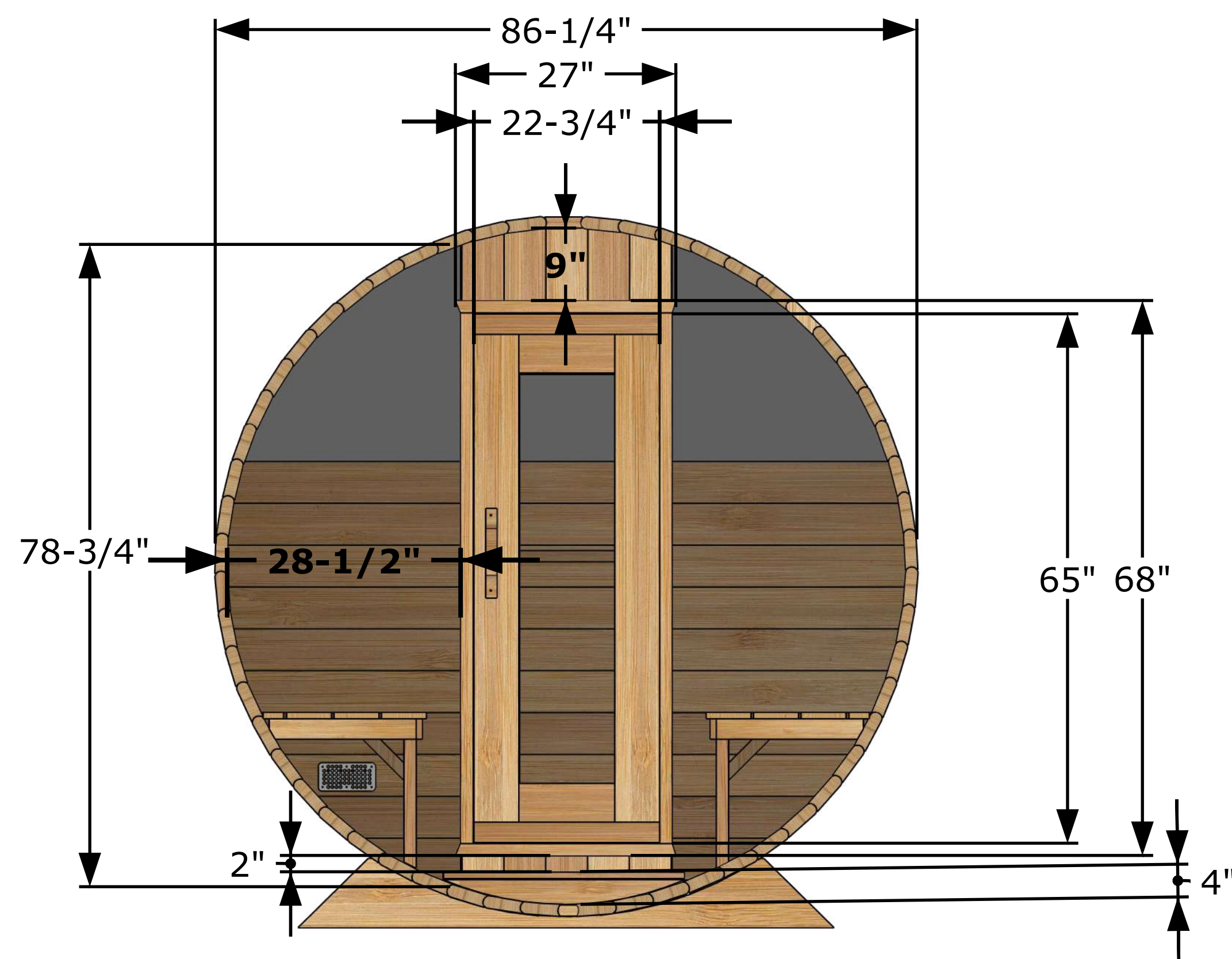

Rear View

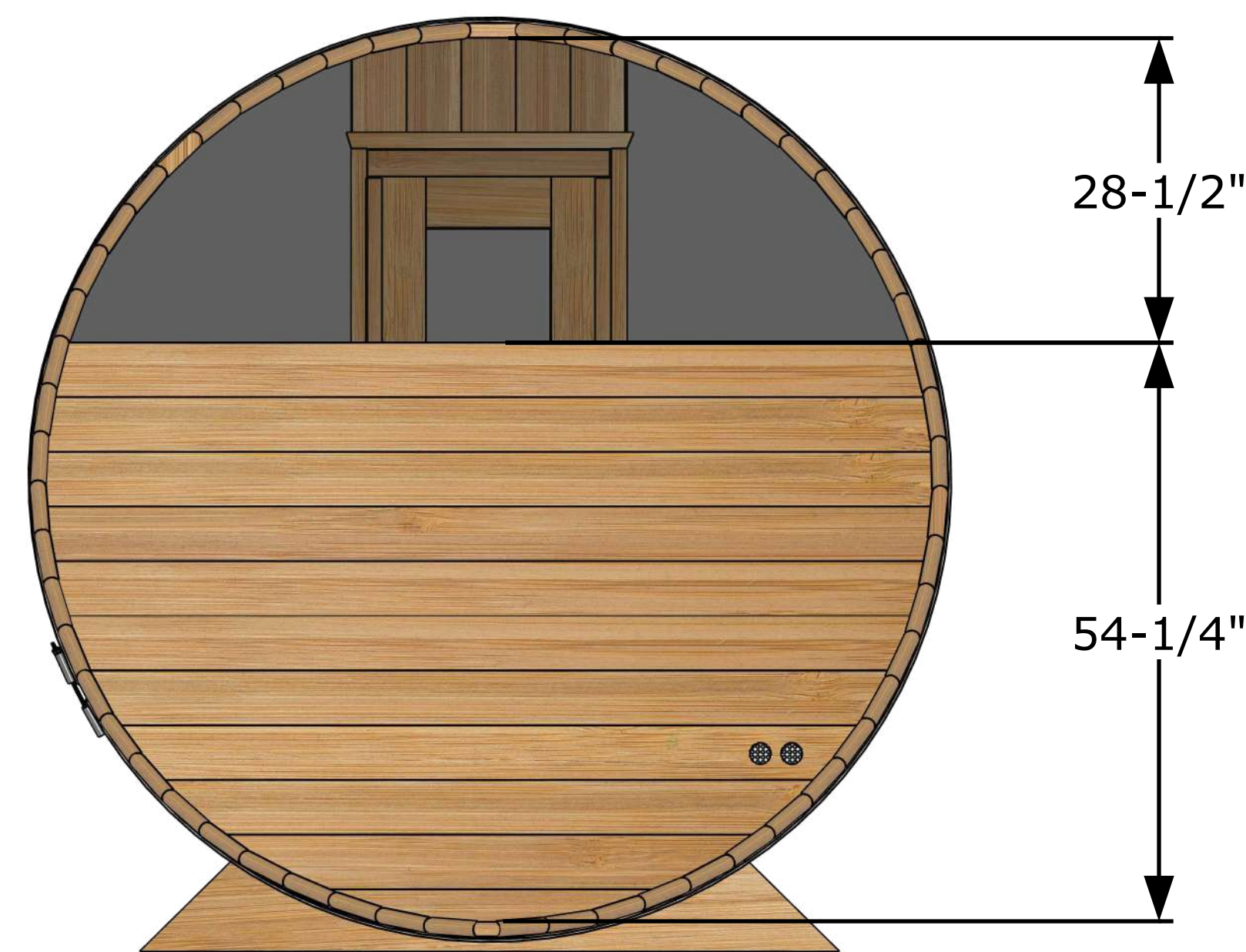

Side View

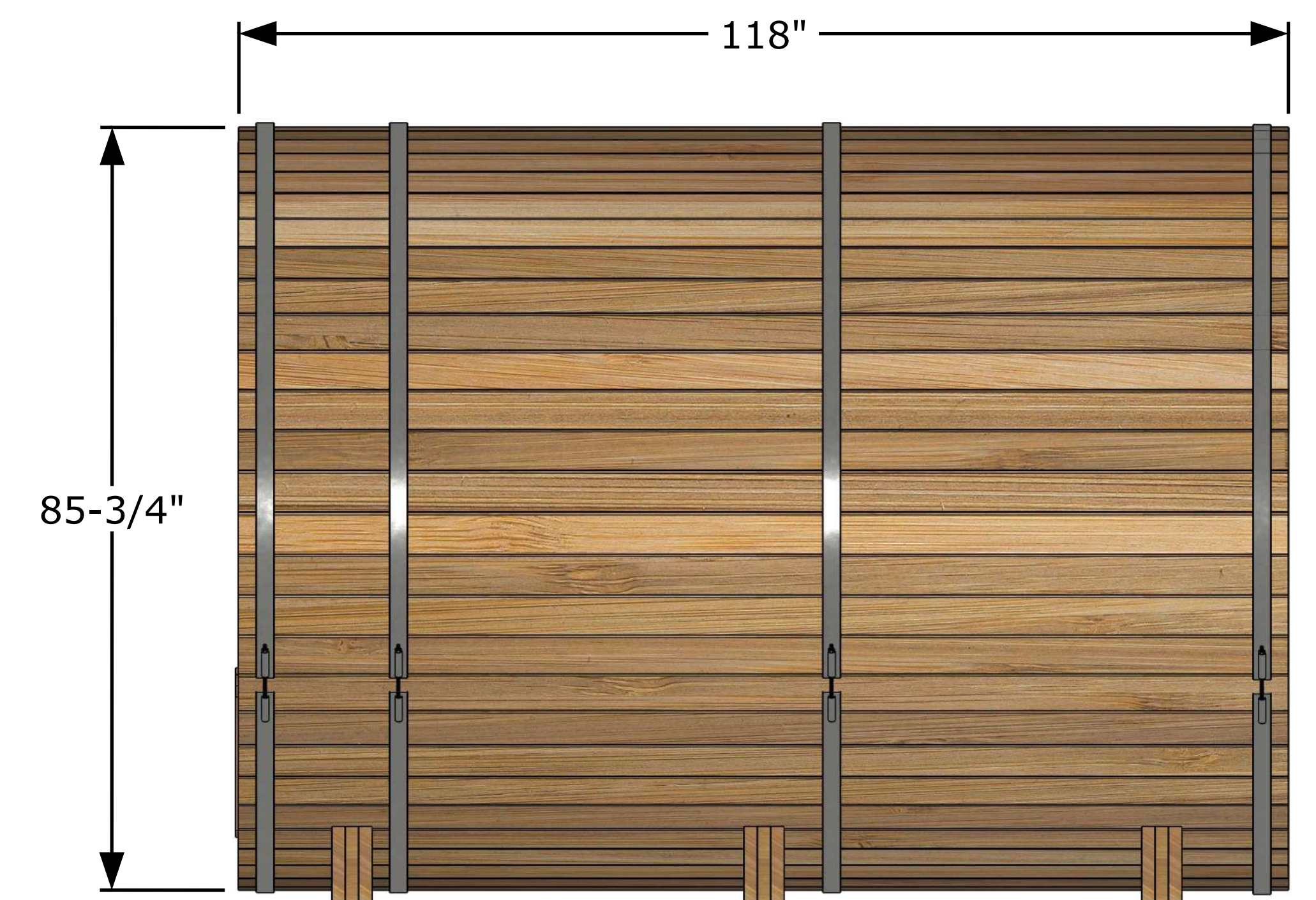

Top View

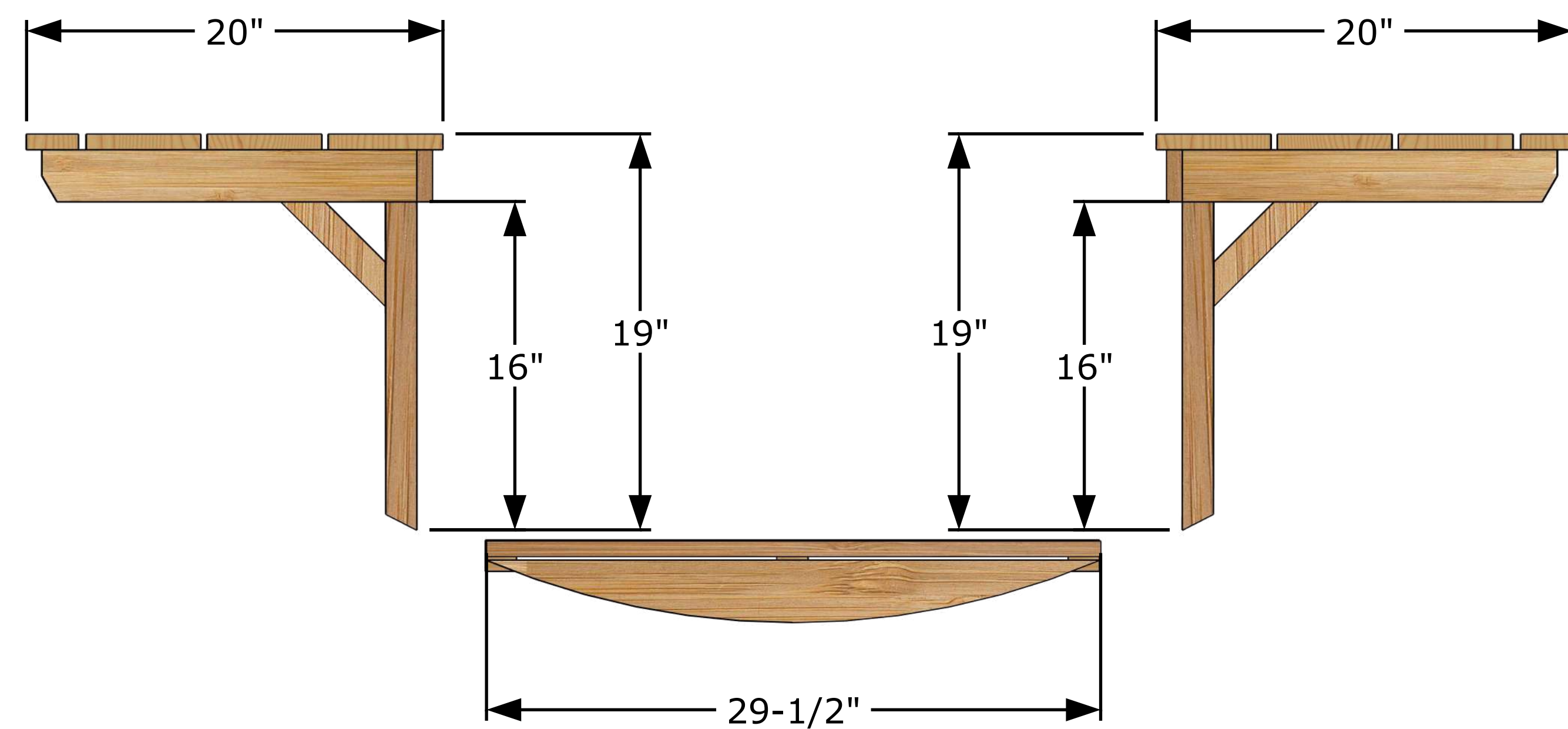

Xray View

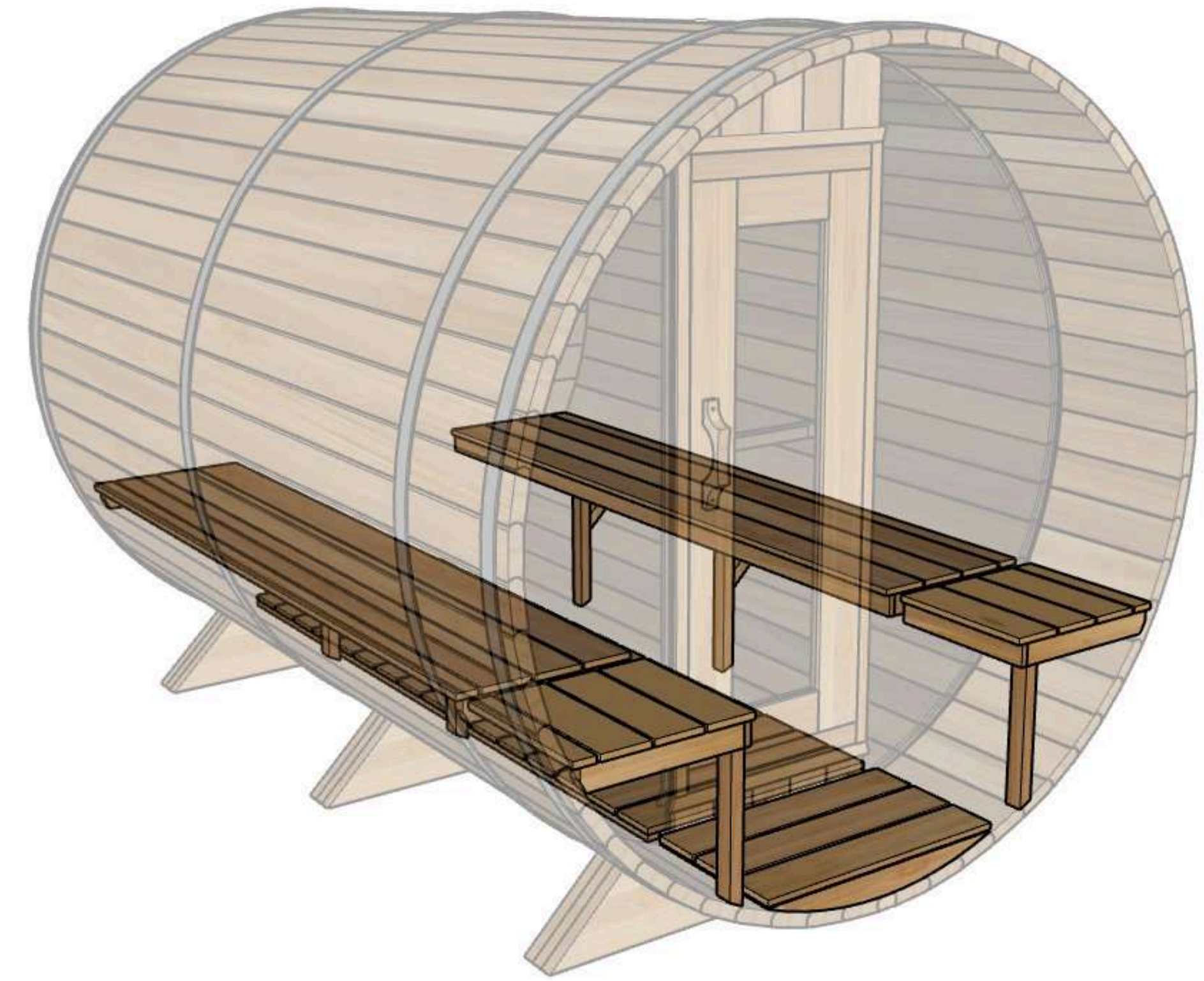

Front View

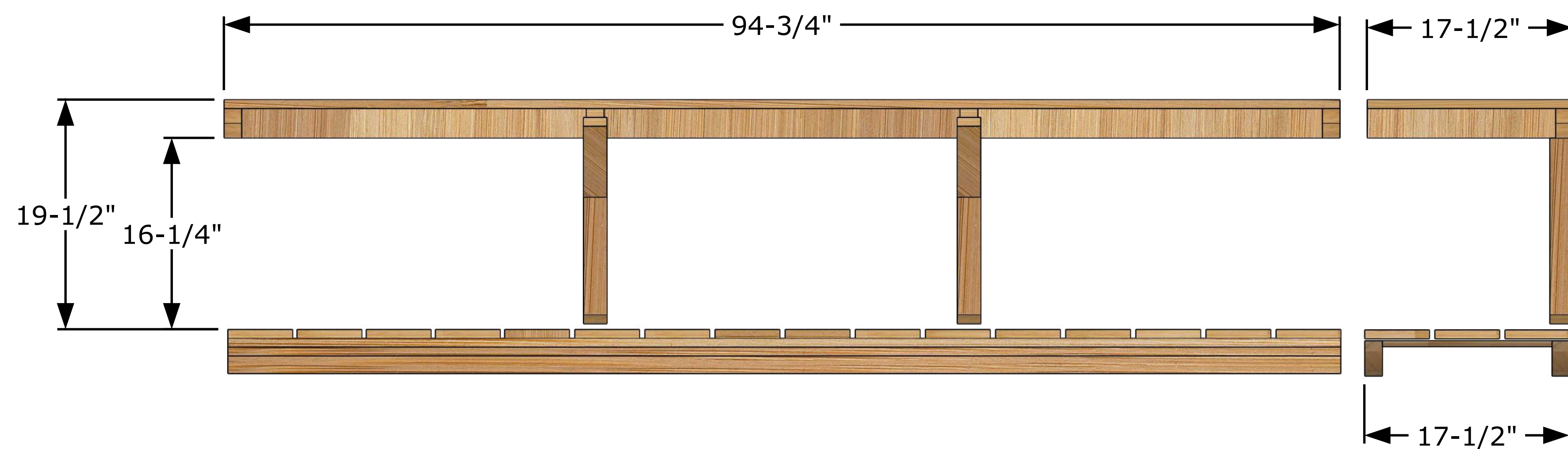

Side View

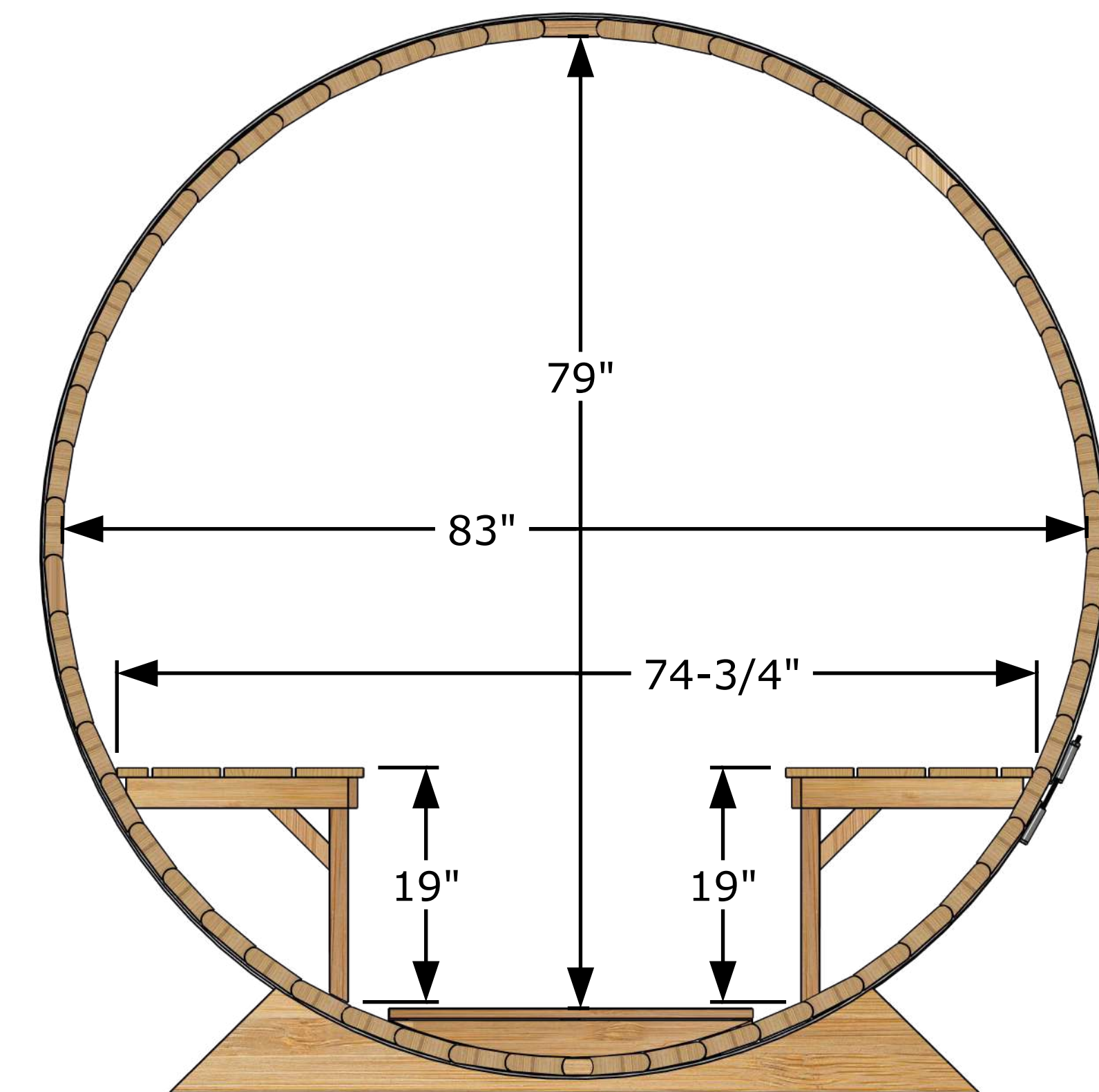



Canadian Timber Serenity/Tranquility MP Barrel Sauna Assembly Instructions



Requirements:

2 People (recommended)
3/4" (19mm) Wrench/Nut Driver Bit
Rubber Mallet
Carpenter's Level
Tape Measure
Cordless Drill
Carpenter's Hammer
Jigsaw
3/4" (19mm) Spade Bit

Phillips & Robertson Drill Bits
2" (51mm) hole saw
Step Ladder
Utility Knife
Adjustable Wrench
7/16" (11mm) Socket
Staple Gun
5/16" (8mm) Nut Driver Bit
Caulking Gun

Manufactured by:



Congratulations on the purchase of your Canadian Timber MP Serenity/Tranquility Barrel Sauna

Please read this entire manual before proceeding with the assembly.

Some details between this installation manual and the video may not be exactly same as Leisurecraft is continually trying to improve the quality of our products and ease of assembly. Please refer to this installation manual for the latest version.

Always ensure that you have the correct screw length so that there will be enough thread to hold, and especially, so that the screw does not go all the way through the material and come out the other side.

Every attempt has been made to make the installation information as clear as possible.

All electrical connections must be performed by a qualified licenced electrician!

For further information on your heater and installation instructions, please refer to the provided heater manual.

Thank you for choosing Leisurecraft!

Manufactured by:



tel: 888-923-9813 | info@leisurecraft.com | web: www.leisurecraft.com

Canadian Timber Serenity/Tranquility MP Barrel Sauna Assembly Instructions

Index

Base Preparation

Barrel Assembly

Adding a spacer to the Top Stave

Making a Top Stave Narrower

Bench Installation

Electric Heater Installation (Option)

Wood Heater Installation (Chimney out the top) (Option)

Wood Heater Installation (Chimney out the back wall) (Option)

Asphalt Shingle Roof Installation

Metal Roof Installation

Care & Maintenance

Warranty

Manufactured by:



tel: 888-923-9813 | info@leisurecraft.com | web: www.leisurecraft.com

Canadian Timber Serenity/Tranquility MP Barrel Sauna Assembly Instructions

Sauna Base Preparation

Ensure the base for your sauna is level with a slight slope to the back for drainage.

A solid base for your sauna is recommended and can be made from the following.



Concrete Pad



Wood Deck



Crushed Stone



Patio Stone/Paver Blocks

It is recommended to build a base larger than required to provide a sitting area for cooling off during your sauna session.

Manufactured by:



tel: 888-923-9813 | info@leisurecraft.com | web: www.leisurecraft.com

Canadian Timber Serenity/Tranquility MP Barrel Sauna Assembly Instructions

Barrel Assembly



Place the cradles onto the sauna base.

If a Tranquility is ordered, it will have an extra cradle.

Center it between the front and back cradles.



Locate bottom stave (convex on either side).

The long part before the groove will face the front.



Center the stave onto the cradle and measure 5 ½" (14cm) from the end of the stave to the edge of the cradle.



Secure the stave with a 3" (76mm) screw.

Ensure that the stave is square and add 3 more 3" (76mm) screws into each corner of the cradle.

Manufactured by:



tel: 888-923-9813 | info@leisurecraft.com | web: www.leisurecraft.com

Canadian Timber Serenity/Tranquility MP Barrel Sauna Assembly Instructions

Barrel Assembly



Repeat this process for the front of the Sauna.



Place 3 staves on either side of the bottom stave and align the grooves.

Ensure the staves are tight together, tap with a rubber mallet if required.



Place 2- 3" (76mm) screws into the 3rd stave on either side lining up with the cradle underneath.

Do not go all the way through the stave at this point.

(This will help align where cradles are in future steps)

Repeat at opposite end.



Place the back bottom wall panel centered into the groove at the rear of the sauna and ensure it is level.

Use a rubber mallet to tap into place if required.

Manufactured by:



tel: 888-923-9813 | info@leisurecraft.com | web: www.leisurecraft.com

Canadian Timber Serenity/Tranquility MP Barrel Sauna Assembly Instructions

Barrel Assembly



Add 3 staves on either side of the sauna.
Use the rubber mallet to finesse into place.



When installing the staves, tap tightly together while leaving as much of a gap as possible between stave and wall using the pencil line as a guide as in picture.

** This will make the tightening of the bands easier.*



Secure every 2nd stave on the bottom of the sauna with the provided nails to hold staves in place.
(If required)

** Once past the middle point of sauna, nails should no longer be needed.*



Place the middle back wall panel onto the bottom panel and secure with 2 ½" (64mm) screws in the pre drilled holes.

Manufactured by:



tel: 888-923-9813 | info@leisurecraft.com | web: www.leisurecraft.com

Canadian Timber Serenity/Tranquility MP Barrel Sauna Assembly Instructions

Barrel Assembly



Place the provided wall support piece onto the front of the sauna.

Repeat on other side.



Continue adding staves on both sides until you get close to the height of the back wall.



Place the window support piece onto the back wall.



Ensure the curve follows the curve off the wall.

Manufactured by:



tel: 888-923-9813 | info@leisurecraft.com | web: www.leisurecraft.com

Canadian Timber Serenity/Tranquility MP Barrel Sauna Assembly Instructions

Barrel Assembly

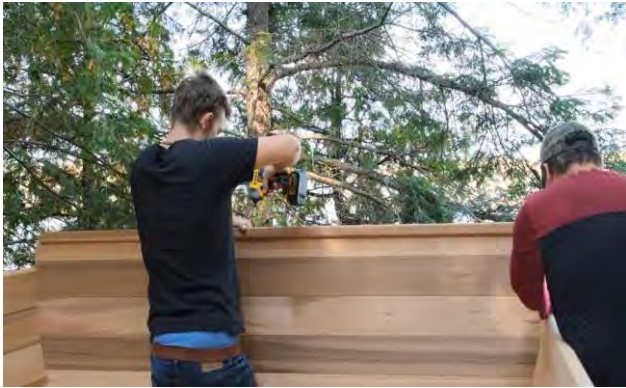

Secure with 5 – 1 ½" (38mm) screws.

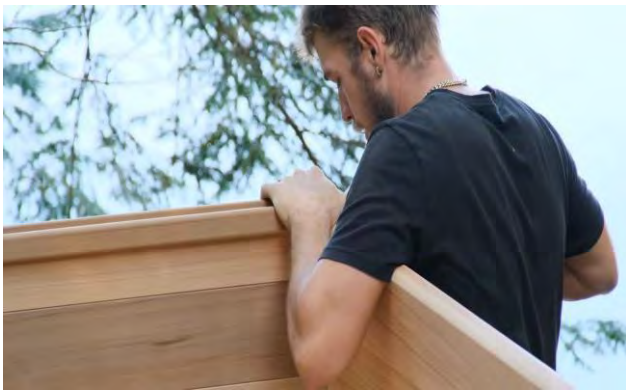

Install another stave on each side of the sauna and secure into the wall using 2 ½" (64mm) screws.



Place the door panel into the front groove of the Sauna.



Using a level and rubber mallet, tap the door until it is centered and level.

Manufactured by:



tel: 888-923-9813 | info@leisurecraft.com | web: www.leisurecraft.com

Canadian Timber Serenity/Tranquility MP Barrel Sauna Assembly Instructions

Barrel Assembly



Slide the first Glass wall panel into the groove.

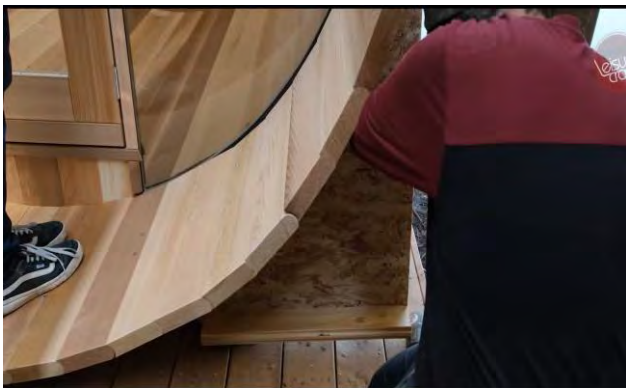

Use the wall support piece to push the wall snug into the window panel.

Secure the support piece to the cradle so it does not move.

This is temporary and will be removed later.

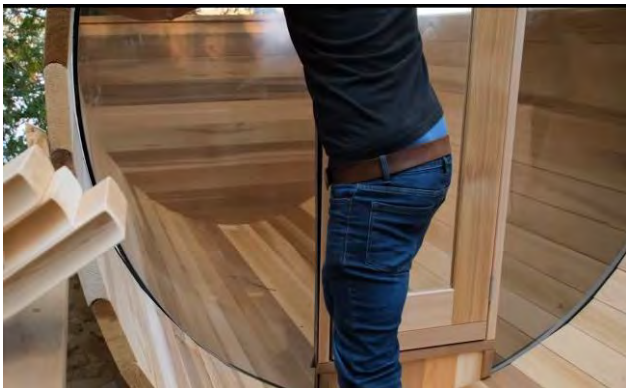

Repeat the process on the other side with the second Glass wall panel



Place 9 more staves onto one side of the sauna.

Manufactured by:



tel: 888-923-9813 | info@leisurecraft.com | web: www.leisurecraft.com

Canadian Timber Serenity/Tranquility MP Barrel Sauna Assembly Instructions

Barrel Assembly



Slide the rear half moon window into the groove on the back wall and make sure it is snug into the wall.



Place the remaining staves working your way to the top of the sauna.



Wedge the top center stave (concave on both sides) with the last stave, to create a "V" shape.



Pre-assemble the front and back bands and thread the nut on just enough to hold it together.

Manufactured by:



tel: 888-923-9813 | info@leisurecraft.com | web: www.leisurecraft.com

Canadian Timber Serenity/Tranquility MP Barrel Sauna Assembly Instructions

Barrel Assembly



Slide the assembled band over the back end of the sauna.



Ensure the band is 2" (51mm) from the edge of the sauna all the way around.



Repeat for the front of the sauna.



Again, ensure the front band is 2" (51mm) from the edge of the sauna all the way around.

Manufactured by:



tel: 888-923-9813 | info@leisurecraft.com | web: www.leisurecraft.com

Canadian Timber Serenity/Tranquility MP Barrel Sauna Assembly Instructions

Barrel Assembly



Lightly snug up the front and back fasteners.



Tap out all the staves while tightening the band ensuring the staves are even.

Repeat for the rear band.



Feed another band over and under the sauna and secure it with a rod and nut.

Ensure all fasteners are the same height.



Place this band directly over the front wall panel making sure it is even all the way around the sauna.

Tighten the band tapping the staves ensuring the staves are even.

Manufactured by:



tel: 888-923-9813 | info@leisurecraft.com | web: www.leisurecraft.com

Canadian Timber Serenity/Tranquility MP Barrel Sauna Assembly Instructions

Barrel Assembly



When the wall staves take on the proper shape, tighten the steel front and back bands completely.

- ***If it doesn't create a "V" shape or there is a gap, you will need to add one of the spacer boards to the top stave.***
- ***In rare instances, your sauna staves will be too tight not allowing the staves to settle into the correct position and you will need to make the top stave narrower.***

Manufactured by:



tel: 888-923-9813 | info@leisurecraft.com | web: www.leisurecraft.com

Canadian Timber Serenity/Tranquility MP Barrel Sauna Assembly Instructions

Adding a Spacer to Top Stave (if required)



In your sauna package you will find a spacer stave that is square on both sides that is only required if there happens to be a “gap” after installing all the staves like in the picture on the left.



To add the spacer, start by removing all of the screws from the top stave.



With the top stave in 2 pieces secure the spacer stave to the half of the top stave without the screws with 2” (51mm) screws.



Now screw the other side of the top stave back to the other half top stave and it should now make a “V” shape when wedged with the last stave on the sauna.

Manufactured by:



tel: 888-923-9813 | info@leisurecraft.com | web: www.leisurecraft.com

Canadian Timber Serenity/Tranquility MP Barrel Sauna Assembly Instructions

Making the Top Stave Narrower (if required)



In rare instances, your sauna staves will be too tight not allowing the staves to settle into the correct position. (as in picture to the left)

This doesn't happen often, and the sauna staves and bands are always better being as tight as possible.



To make the top stave narrower, start by removing all of the screws from the top stave.



Once top stave is apart, Measure from flat edge 3/4 " (2cm) on each piece and safely cut to make staves thinner.



Now screw the 2 cut pieces of the top stave back together.

Reinstall the top stave and it should now make a "V" shape when wedged with the last stave on the sauna.

Manufactured by:



tel: 888-923-9813 | info@leisurecraft.com | web: www.leisurecraft.com

Canadian Timber Serenity/Tranquility MP Barrel Sauna Assembly Instructions

Barrel Assembly



Feed another band over and under the sauna and secure it with a rod and nut.

Center it between the bands on either side of it and tighten up in the same manner as before.

Tighten all bands up completely.

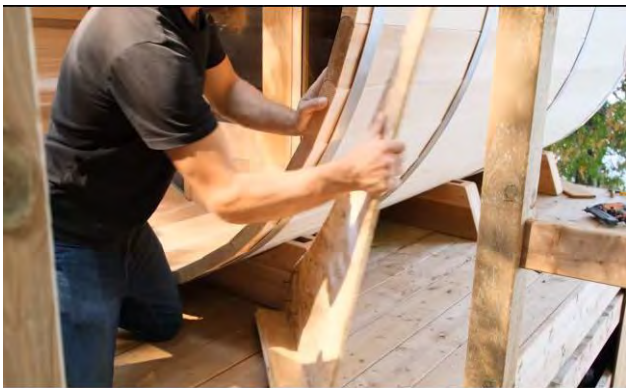

Remove the temporary front wall support pieces from either side.



Now finish screwing in the screws that we started earlier into the cradles.

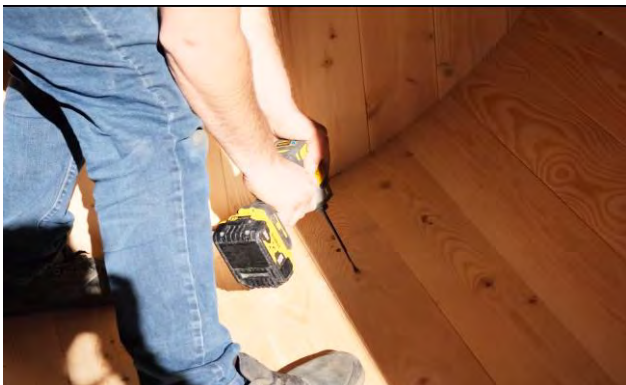

Repeat this process for the screws inside the sauna as well.

Manufactured by:



tel: 888-923-9813 | info@leisurecraft.com | web: www.leisurecraft.com

Canadian Timber Serenity/Tranquility MP Barrel Sauna Assembly Instructions

Barrel Assembly



Use the caulking to seal the seams on the outside of the rear window.



Repeat on the outside of the front half moon windows.

Manufactured by:



tel: 888-923-9813 | info@leisurecraft.com | web: www.leisurecraft.com

Canadian Timber Serenity/Tranquility MP Barrel Sauna Assembly Instructions

Bench Installation



Place the first flat floor piece inside the sauna towards the back wall.

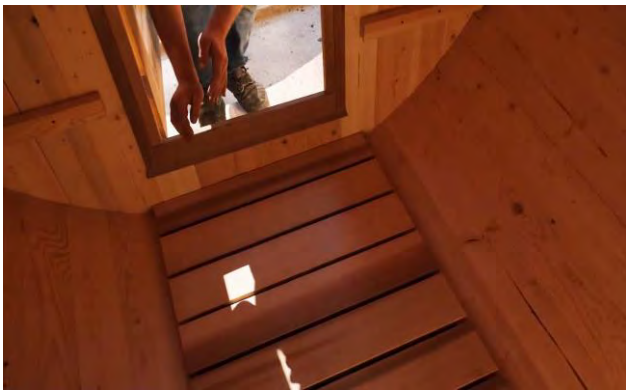

Place the second floor piece inside sauna, ensuring they are snug up to the front wall.

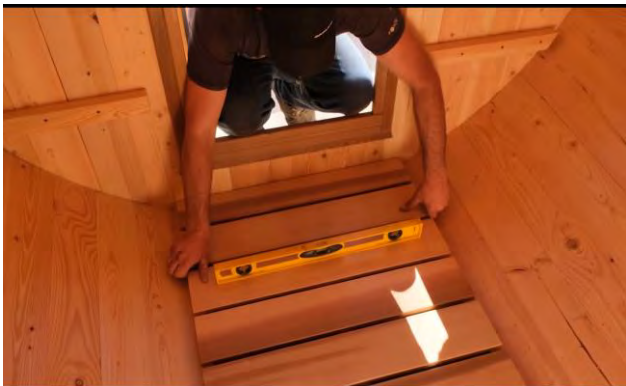

Ensure the floor pieces are level.

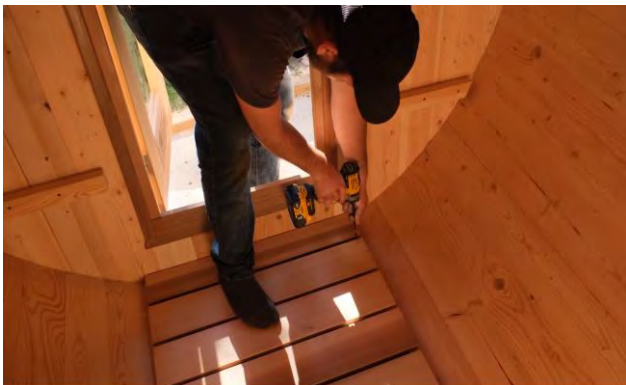

Once level, Secure the floor with 1 ½" (38mm) screws in the 4 corners of each floor piece screwing between the floorboards so the screws are not as visible.

Manufactured by:



tel: 888-923-9813 | info@leisurecraft.com | web: www.leisurecraft.com

Canadian Timber Serenity/Tranquility MP Barrel Sauna Assembly Instructions

Bench Installation

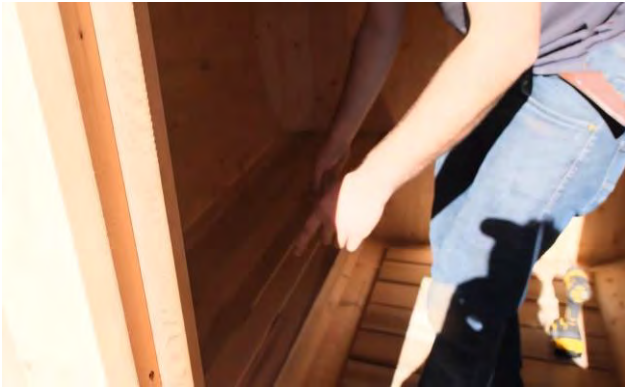

Bring in the benches and place on bench brackets.

Ensure they are tight against the walls.

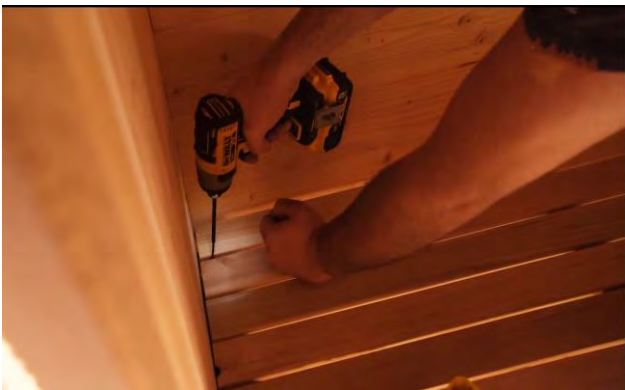

Secure the benches to the bench brackets with 1 ½" (38mm) screws in each of the corners of the bench screwing between the bench slats so the screws are not as visible.



Place 2 – 1 ½" (38mm) screws into the pre-drilled holes on each bench bracket.

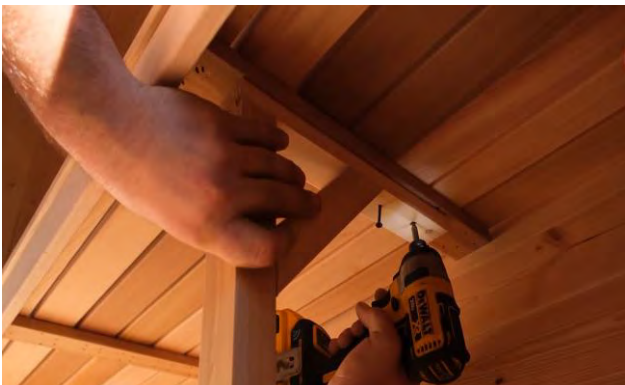

Line the bracket up with the support on the bottom of the bench and secure it with the pre-placed screws.

Manufactured by:



tel: 888-923-9813 | info@leisurecraft.com | web: www.leisurecraft.com

Canadian Timber Serenity/Tranquility MP Barrel Sauna Assembly Instructions

Bench Installation



Square up the bench support and use a 1 ½" (38mm) screw in the pre-drilled hole to secure it to the sauna floor.

Repeat this process for the remaining bench supports.

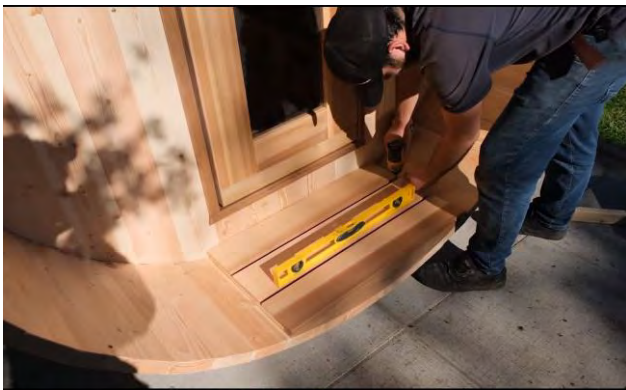

Center the porch floor and ensure it is level.

Once level, Secure the floor with 1 ½" (38mm) screws in the 4 corners of the floor screwing between the floorboards so the screws are visible.

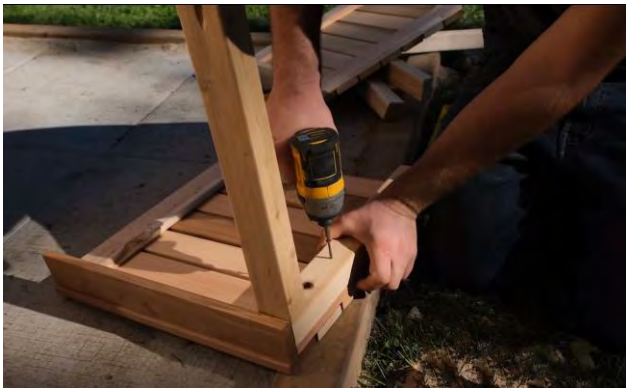

Screw the porch bench bracket to the porch seat with 3- 3" (76mm) screws.

Ensure the bracket is installed with the pre-drilled hole at the bottom of the bracket.



Secure the wall support on its edge to the porch seat with 2- 3" (76mm) screws.

Add 2- 3" (76mm) screws on the inside of the wall support to make mounting easier.

Manufactured by:



tel: 888-923-9813 | info@leisurecraft.com | web: www.leisurecraft.com

Canadian Timber Serenity/Tranquility MP Barrel Sauna Assembly Instructions

Bench Installation



Place the bench against the wall and make sure that it is level.



Secure the 2 screws that were installed in the last step to the sauna wall.

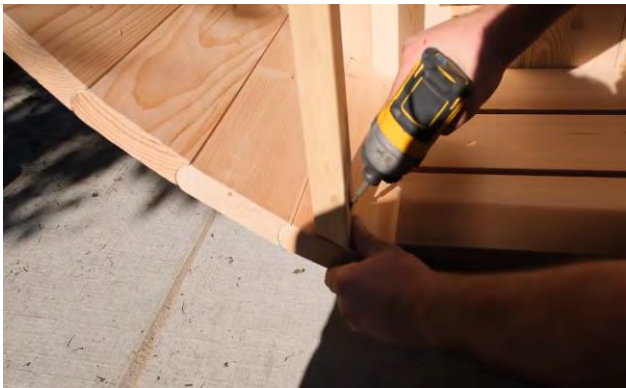

Ensure the bench support is flush with the edge of sauna and use a 1 ½" (38mm) screw in the pre-drilled hole to secure it to the sauna floor.

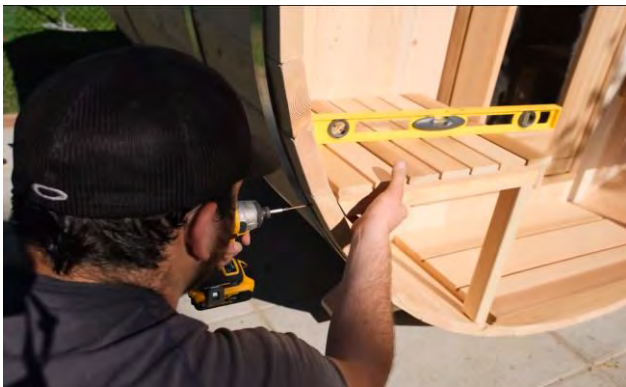

Use a 3" (76mm) screw to go through the sauna stave into the front of the bench bracket.

Repeat for porch bench on other side.

Manufactured by:



tel: 888-923-9813 | info@leisurecraft.com | web: www.leisurecraft.com

Canadian Timber Serenity/Tranquility MP Barrel Sauna Assembly Instructions

Bench Installation



Install the outer door handle (small) at the desired height using 2 - 3" (76mm) screws in the pre-drilled holes.

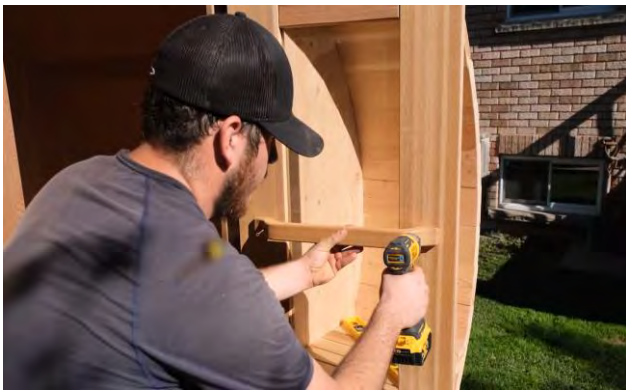

Install the inner door handle (large) horizontally at the desired height. Ensure the handle is level and secure using 2 - 3" (76mm) screws in the pre-drilled holes.



Place the towel hook at desired location and secure with 4- 1 ½" (38mm) screws.

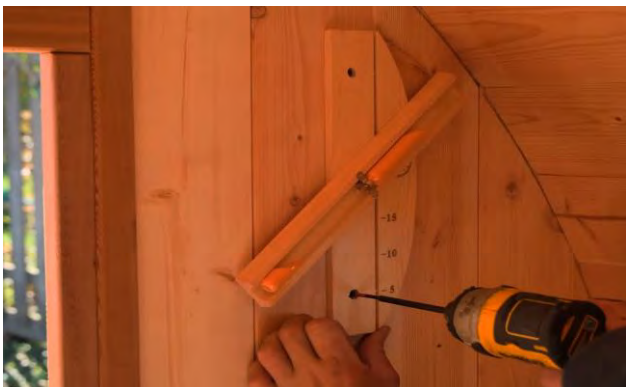

Install the optional sand timer using 2 - 1 ½" (38mm) screws.

Ensure it can rotate without hitting the wall.

Manufactured by:



tel: 888-923-9813 | info@leisurecraft.com | web: www.leisurecraft.com

Canadian Timber Serenity/Tranquility MP Barrel Sauna Assembly Instructions

Electric Heater Installation (Optional)



Measure the width of the stove mounting holes.



Measure the height of the mounting holes and add 6". (152mm)



Transfer the measurements to the back wall of sauna.

Ensure the heater will be centered between the benches.



Install the two $\frac{1}{4}$ " x $1\frac{1}{2}$ " (6mm x 38mm) hex head lag screws (supplied with the heater) into the holes.

Manufactured by:



tel: 888-923-9813 | info@leisurecraft.com | web: www.leisurecraft.com

Canadian Timber Serenity/Tranquility MP Barrel Sauna Assembly Instructions

Electric Heater Installation (Optional)



Hang the heater on the 2 screws and tighten to secure stove in position.



Locate the pieces for your heater guard.

Stand the 2 Assembled side pieces of the heater guard on edge with pre-drilled holes on the bottom.



Screw heater guard support to either side using (2) – 1 ½" (38mm) screws per side.

Repeat for the bottom heater guard support.



Place 2- 2 ½" (64mm) screws into the pre-drilled holes on either side of heater guard to prepare for mounting.

Manufactured by:



tel: 888-923-9813 | info@leisurecraft.com | web: www.leisurecraft.com

Canadian Timber Serenity/Tranquility MP Barrel Sauna Assembly Instructions

Electric Heater Installation (Optional)



Center the guard around the heater and secure to wall with the preplaced screws.



Ensure the guard is level and secure the other side.



Wash the layer of rock dust off of the sauna rocks before using them.

When your sauna is set up and working you should “break-in” the sauna before using it for the first time by turning on the heater to its highest setting and operate it for about 1 hour.

This is recommended to burn off any oils impurities from manufacturing, and it also “cures” the woodwork.

• ***All wiring should be installed according to the heater manufacturers instructions and by a licensed electrician.***

• **Do NOT use a G.F.I breaker**

Manufactured by:



tel: 888-923-9813 | info@leisurecraft.com | web: www.leisurecraft.com

Canadian Timber Serenity/Tranquility MP Barrel Sauna Assembly Instructions

Wood Stove Installation (Chimney out the top) (Optional)



Remove all protective film from stainless steel parts and the plastic wrap from stove pipe pieces before installation.



Fasten the stove handle onto the stove door With the screws provided.

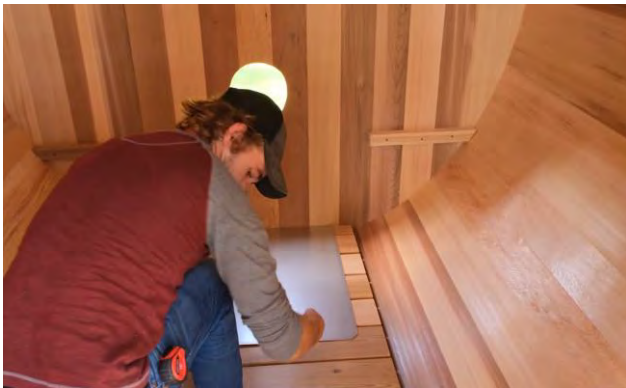

Install floor heat shield against back wall centered between the benches.

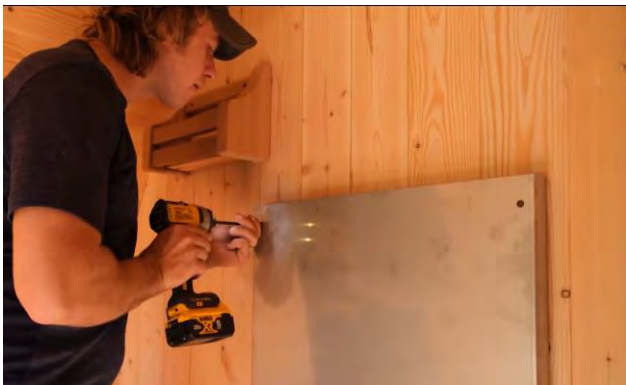

Place the rear wall heat shield and secure with 6 - 1 ½" (38mm) screws through the drilled holes.

Manufactured by:



tel: 888-923-9813 | info@leisurecraft.com | web: www.leisurecraft.com

Canadian Timber Serenity/Tranquility MP Barrel Sauna Assembly Instructions

Wood Stove Installation (Chimney out the top) (Optional)



Bring in the stove and ensure it is centered between the benches with the chimney hole 8" (203mm) from the rear heat shield.



On the top of the sauna, measure 12" (305mm) from the end of staves.

From the mark, make an 8" (203mm) circle.



Cut the circle out with a jigsaw.



Place the long chimney piece onto the stove.

Manufactured by:



tel: 888-923-9813 | info@leisurecraft.com | web: www.leisurecraft.com

Canadian Timber Serenity/Tranquility MP Barrel Sauna Assembly Instructions

Wood Stove Installation (Chimney out the top) (Optional)



Place the first thick insulated chimney pipe on top of the first pipe and put it through the hole in the roof.



On the top of the sauna, pull the boot over the pipe, mark the outline of the boot.



Lift the boot out of the way and apply the included roof sealer on the inside of the outline.

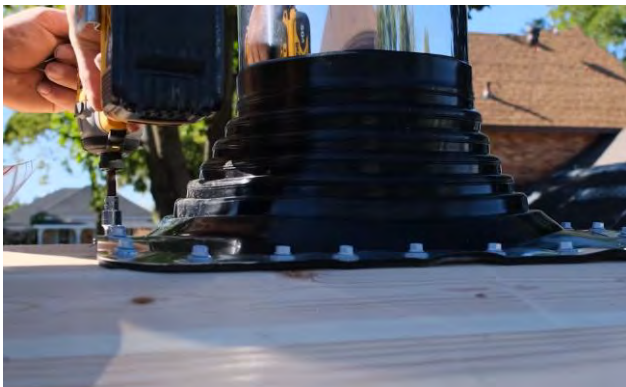

Pull the boot back down and secure with the included self-sealing roofing screws 2-3" (51mm to (76mm)) apart.

Manufactured by:



tel: 888-923-9813 | info@leisurecraft.com | web: www.leisurecraft.com

Canadian Timber Serenity/Tranquility MP Barrel Sauna Assembly Instructions

Wood Stove Installation (Chimney out the top) (Optional)



Place the hose clamp over the boot and tighten the screw.



Place the 2nd insulated chimney piece over the first.



Attach the support strap around the 2 chimney pipes and tighten up.



Insert the short chimney piece into the thick chimney piece, followed by the cap piece.

Manufactured by:



tel: 888-923-9813 | info@leisurecraft.com | web: www.leisurecraft.com

Canadian Timber Serenity/Tranquility MP Barrel Sauna Assembly Instructions

Wood Stove Installation (Chimney out the top) (Optional)



Install the 2 halves of the thin metal sheeting around the chimney on the inside to cover the hole.

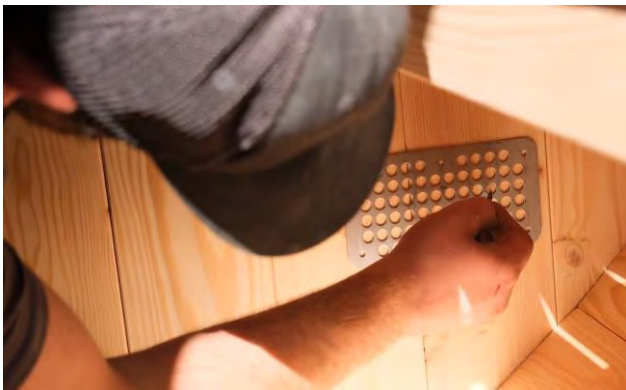

Below the bench support on the back wall, mark the vent hole position.



Drill out with a 2" (51mm) hole saw.

Only go half way through to prevent splintering and drill the remainder from the other side of wall.

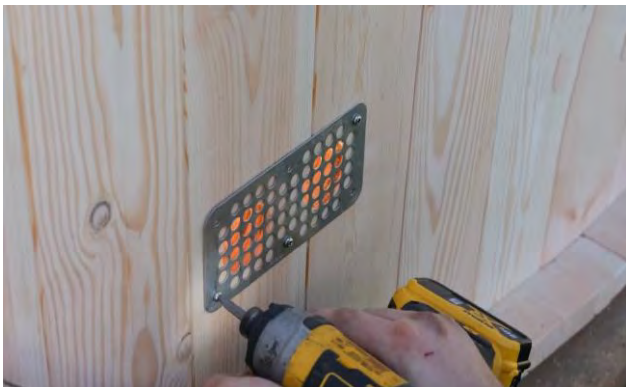

Using 1 ½" (38mm) screws, screw on the vent cover.

(note that the vent guard only goes on the outside.)

Manufactured by:



tel: 888-923-9813 | info@leisurecraft.com | web: www.leisurecraft.com

Canadian Timber Serenity/Tranquility MP Barrel Sauna Assembly Instructions

Wood Stove Installation (Chimney out the top) (Optional)



High on the front wall, repeat this process and mount the vent cover on the outside of the sauna.

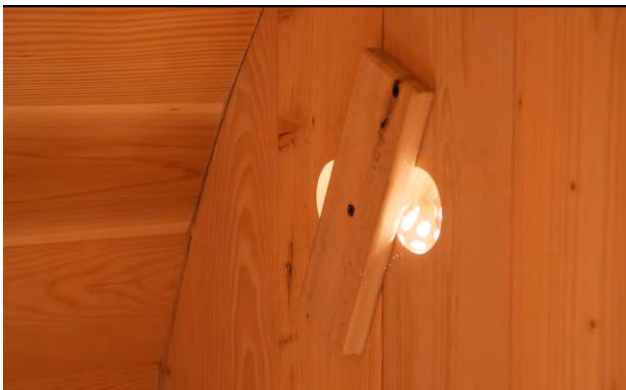

Use a 1 ½" (38mm) screw and attach the vent board on the inside of the sauna making sure it is tight but can still be turned.



The assembly of your wood stove with chimney out the top is now complete.

Enjoy your sauna!

Manufactured by:



tel: 888-923-9813 | info@leisurecraft.com | web: www.leisurecraft.com

Canadian Timber Serenity/Tranquility MP Barrel Sauna Assembly Instructions

Wood Stove Installation (Chimney out the back wall) (Optional)



Remove all protective film from stainless steel parts and the plastic wrap from stove pipe pieces before installation.



Fasten the stove handle onto the stove door With the screws provided.



Remove the screw on the back of stove and remove the back flap.



Measure the height to the middle of the opening on the back of stove. (22") (56mm)

Manufactured by:



tel: 888-923-9813 | info@leisurecraft.com | web: www.leisurecraft.com

Canadian Timber Serenity/Tranquility MP Barrel Sauna Assembly Instructions

Wood Stove Installation (Chimney out the back wall) (Optional)



On the center of the back wall, measure 22" (56mm) from the floor up.

This will be the center of your hole for the chimney to go out.

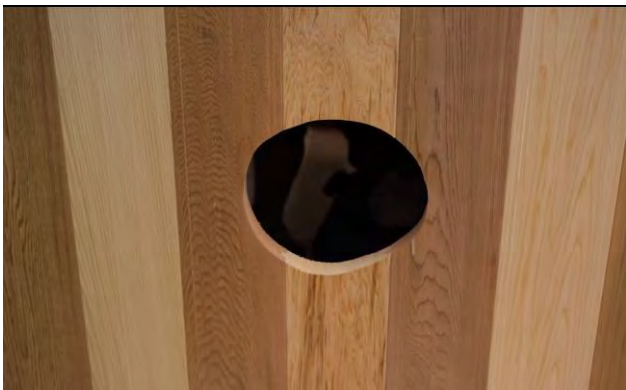

From the mark, make an 8" (203mm) circle.

Cut out the circle with a jigsaw.

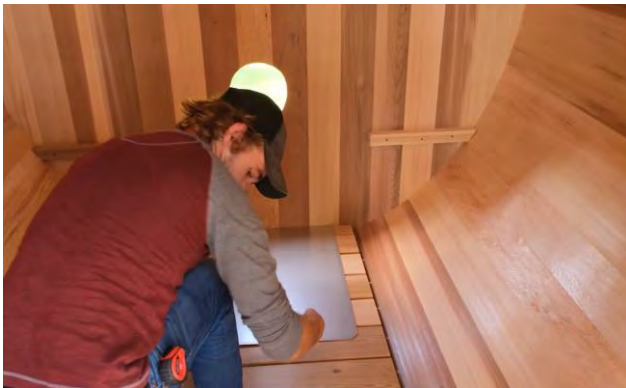

Install floor heat shield against back wall centered between the benches.

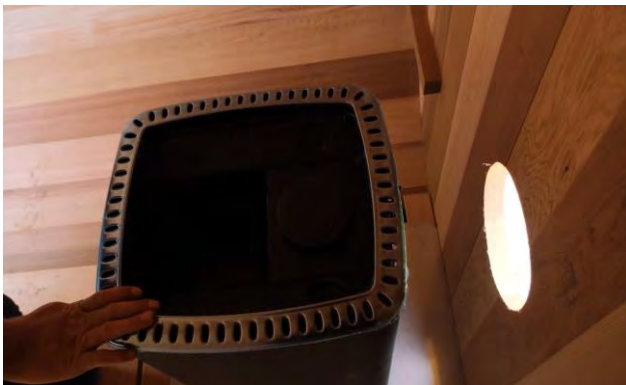

Bring in stove and place it on the floor heat shield.

Manufactured by:



tel: 888-923-9813 | info@leisurecraft.com | web: www.leisurecraft.com

Canadian Timber Serenity/Tranquility MP Barrel Sauna Assembly Instructions

Wood Stove Installation (Chimney out the back wall) (Optional)



Bring in the rear wall heat shield and place it behind the stove.



Insert the "T" chimney piece through hole in back of sauna and through the rear wall heat shield on the inside of sauna and into the back of stove.

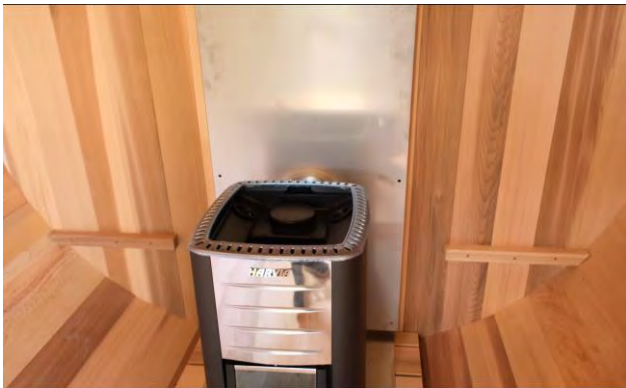

Ensure the rear wall heat shield is level and secure with 6 - 1 ½" (38mm) screws through the drilled holes.



Remove the nuts and bolts from the chimney support.

Manufactured by:



tel: 888-923-9813 | info@leisurecraft.com | web: www.leisurecraft.com

Canadian Timber Serenity/Tranquility MP Barrel Sauna Assembly Instructions

Wood Stove Installation (Chimney out the back wall) (Optional)



Assemble together the remaining chimney pieces.



Attach the support strap around the 2 chimney pipes and tighten up.



Attached assemble chimney pieces to the "T" coming out the back of the sauna.

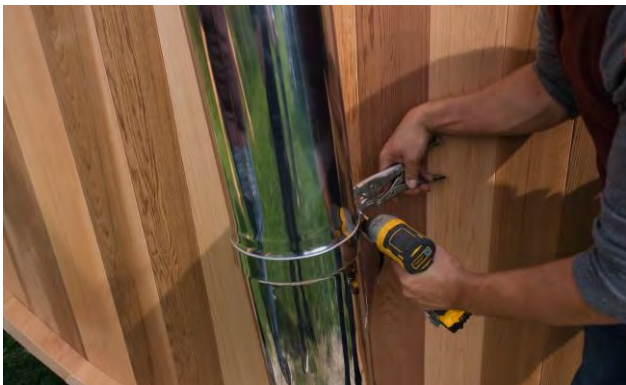

Attach a support strap around the connection and tighten up.

Manufactured by:



tel: 888-923-9813 | info@leisurecraft.com | web: www.leisurecraft.com

Canadian Timber Serenity/Tranquility MP Barrel Sauna Assembly Instructions

Wood Stove Installation (Chimney out the back wall) (Optional)



Reassemble the top chimney support bracket.

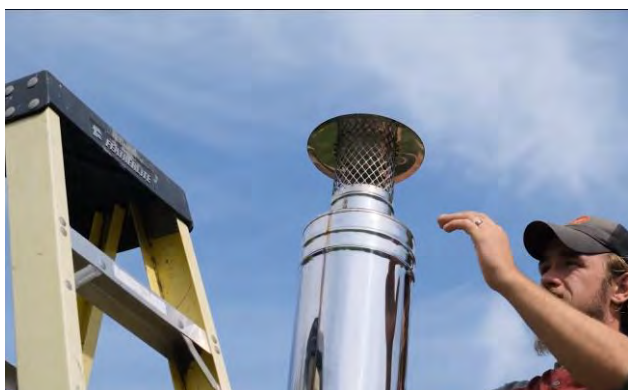

Install the cap on the top of the assembled chimney.



Install the bottom half of the exterior chimney shield.

Ensure that it is level.

Overlap the top half of the exterior chimney shield and secure with provided screws.

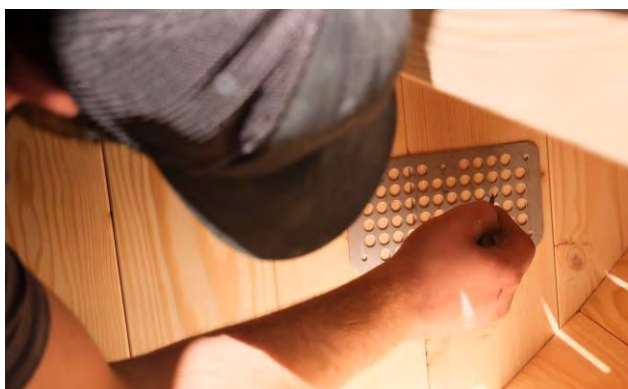

Below the bench support on the back wall, mark the vent hole position.

Manufactured by:



tel: 888-923-9813 | info@leisurecraft.com | web: www.leisurecraft.com

Canadian Timber Serenity/Tranquility MP Barrel Sauna Assembly Instructions

Wood Stove Installation (Chimney out the back wall) (Optional)



Drill out with a 2" (51mm) hole saw.

Only go halfway through to prevent splintering and drill the remainder from the other side of wall.

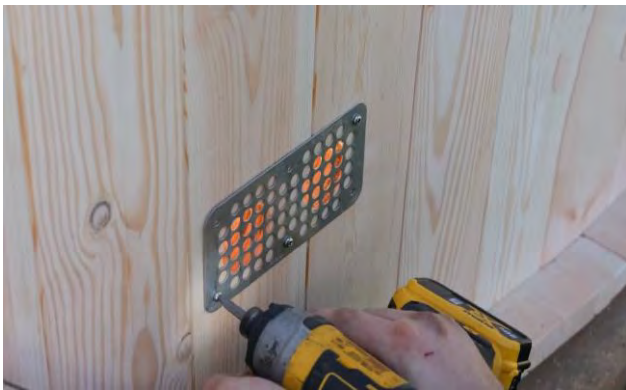

Using 1 ½" (38mm) screws, screw on the vent cover.

(note that the vent guard only goes on the outside.)



High on the front wall, repeat this process and mount the vent cover on the outside of the sauna.

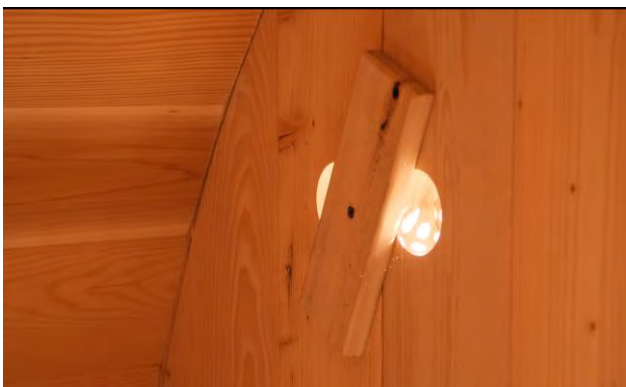

Use a 1 ½" (38mm) screw and attach the vent board on the inside of the sauna making sure it is tight but can still be turned.

Manufactured by:



tel: 888-923-9813 | info@leisurecraft.com | web: www.leisurecraft.com

Canadian Timber Serenity/Tranquility MP Barrel Sauna Assembly Instructions

Asphalt Shingle Roof Installation (Optional)



Preplace 2" (51mm) screws into the triangle support pieces.

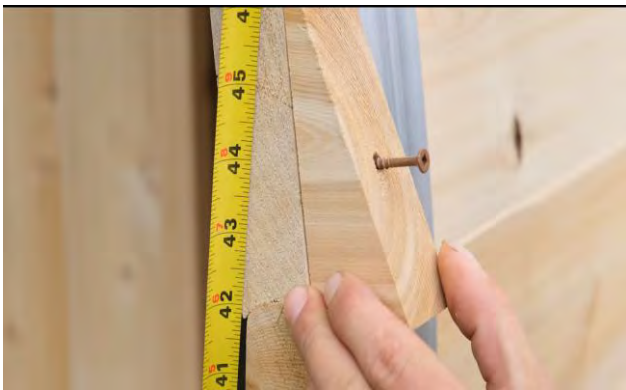

Install the first triangle support piece halfway up the sauna. (42" (107cm) from the base of the sauna)



Install another triangle support in the middle of the sauna and one centered between the 2.



Install a support at 42" (107cm) high at the other end of the sauna.

Install another one in the middle of the sauna and 1 more centered between these 2.

This will make 6 supports across the sauna.

Manufactured by:



tel: 888-923-9813 | info@leisurecraft.com | web: www.leisurecraft.com

Canadian Timber Serenity/Tranquility MP Barrel Sauna Assembly Instructions

Asphalt Shingle Roof Installation (Optional)



Place the ice and water support boards flush to the bottom of the triangle supports and secure with 2 - 1 ½" (38mm) screw in each of the triangle supports.



Add the second ice & water support board to the other half of the sauna and secure to the triangle supports in the same manner.

Repeat for the opposite side of the sauna.



Peel the film off the back of the ice & water shield.



Place it flush to the bottom of the support boards and secure it with roofing nails on the ends.

Manufactured by:



tel: 888-923-9813 | info@leisurecraft.com | web: www.leisurecraft.com

Canadian Timber Serenity/Tranquility MP Barrel Sauna Assembly Instructions

Asphalt Shingle Roof Installation (Optional)



Continue with the next strip of ice & water shield.

Ensure to overlap it on top of the smooth portion of the previous strip.



Tack it down with roofing nails.



Continue this process until all the ice & water shield strips are placed.



Cut off the excess ice & water shield from each end.

Manufactured by:



tel: 888-923-9813 | info@leisurecraft.com | web: www.leisurecraft.com

Canadian Timber Serenity/Tranquility MP Barrel Sauna Assembly Instructions

Asphalt Shingle Roof Installation (Optional)



Install the trim pieces on the front of the sauna using 1 ½" (38mm) screws.



The center trim piece may have to be cut to make it fit.



Begin placing the shingles on the roof and secure with roofing nails.



Continue adding shingles along this row to the back of the sauna.

Manufactured by:



tel: 888-923-9813 | info@leisurecraft.com | web: www.leisurecraft.com

Canadian Timber Serenity/Tranquility MP Barrel Sauna Assembly Instructions

Asphalt Shingle Roof Installation (Optional)



When you get to the back of the sauna, cut off the excess shingle to use to start the next row.



Use the cut piece from the first row to start the next row of shingles.



Continue this row to the end of the sauna and again cut off the excess shingle to start the next row.

Be sure not to hit the aluminum bands with the roofing nails when securing the shingles.



Continue adding shingles in the same manner to the back of the sauna,.

When you get to the 4th row, start the row with a full shingle.

Continue this pattern until you get to the top center of the sauna.

Manufactured by:



Canadian Timber Serenity/Tranquility MP Barrel Sauna Assembly Instructions

Asphalt Shingle Roof Installation (Optional)



Once you get to the center at the top of the sauna, start the process on the other side working your way up to the top again.



When you get to the last row on this side, secure the top row with roofing nails in the top and middle of the shingle.



Install the trim pieces to the back of the sauna in the same manner as the front securing with 1 ½" (38mm) screws.

Again, the center trim piece may have to be cut to fit.



Your Asphalt roof is now complete!

Enjoy!

Manufactured by:



tel: 888-923-9813 | info@leisurecraft.com | web: www.leisurecraft.com

Canadian Timber Serenity/Tranquility MP Barrel Sauna Assembly Instructions

Metal Roof Installation (Optional)



To start the installation of your metal roofing, unpeel the top back of the ice & water shield and stick it to the side of the sauna starting at the middle on one side.



Secure to the sauna with staples across the top of the ice & water shield.



Remove the bottom half of the ice & water shield, stick it to the sauna and secure to the sauna with staples across the bottom.



Place the next strip overlapping the first and continue to the top of the sauna. Secure with staples at the top and bottom of each strip of ice & water shield.

Repeat on other side ensuring pieces overlap at the top of the sauna,

Manufactured by:

Canadian Timber Serenity/Tranquility MP Barrel Sauna Assembly Instructions

Metal Roof Installation (Optional)



Fold the ice & water shield over the front of the staves.



Secure with staples.

Continue stapling to the other side, staples will be hidden by the trim.

Repeat on the rear of the sauna.



Using a utility knife, cut off the excess ice & water shield flush to the edge of the staves on the front and back of the sauna.



Center one of the trim pieces at the bottom on the front of the sauna. Raise it $\frac{1}{2}$ " (13mm) and secure it with 3 - 1 $\frac{1}{2}$ " (38mm) screws.

Manufactured by:

Canadian Timber Serenity/Tranquility MP Barrel Sauna Assembly Instructions

Metal Roof Installation (Optional)



Place the next trim piece. Ensure it is flush with the first trim piece and secure with a 1 ½" (38mm) screw at each end.

Continue with the remaining trim pieces.



It may be necessary to mark and cut the final trim piece to fit.

Repeat for the rear of the sauna.



Carefully remove the metal roofing from the packaging.

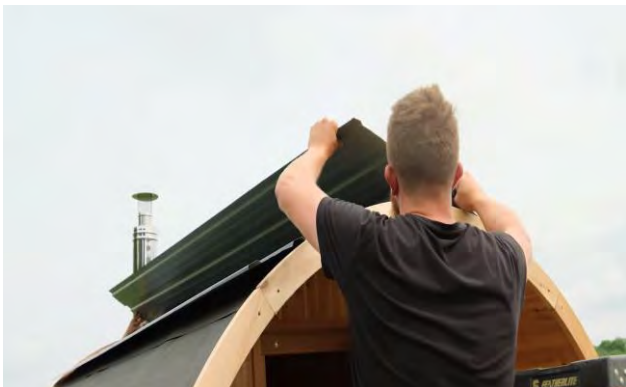

Place 2 panels on to the top of the sauna.

Manufactured by:

Canadian Timber Serenity/Tranquility MP Barrel Sauna Assembly Instructions

Metal Roof Installation (Optional)



Overlap the last ridge of each of the panels together and ensure they are centered on the sauna.



Secure the center of the panels with 8 self-sealing roofing screws.



Place the next panel and ensure the bottom ridge of the previous panel overlaps the top ridge of the bottom panel.



Secure with 5 self-sealing roofing screws into the top and bottom ridges.

Repeat on opposite side of the sauna.

Manufactured by:

Canadian Timber Serenity/Tranquility MP Barrel Sauna Assembly Instructions

Metal Roof Installation (Optional)



Place a final self-sealing screw into the center of the roof.

Add more screws into any of the ridges if necessary.

The assembly of your metal roof is now complete!



Watch the metal roof assembly video here!

[Metal Roof Installation](#)



Manufactured by:



tel: 888-923-9813 | info@leisurecraft.com | [web: www.leisurecraft.com](http://www.leisurecraft.com)

MAINTAINING YOUR SAUNA AFTER INSTALLATION

Interior

It is recommended to vacuum or sweep out the inside of your sauna frequently to remove dirt and other debris. Under normal conditions, a slight wash of the floor and benches with warm soapy water several times a year will maintain its cleanliness. Leisurecraft offers a sauna room cleaner that can be used pure or diluted at a 4-1 ratio. Simply spray and wipe!

You can use a sheet of fine grit sandpaper or a low-pressure wash to remove more stubborn stains or for a deeper cleaning of the interior of your sauna.

Never use ammonia or harsh cleaners as they can turn the wood gray.



Water Seepage

Some minor water seeping into the sauna is expected and normal for an outdoor sauna. If your sauna is properly installed, you should not have water dripping in, but you should expect some water seepage, especially on the top and sides of the sauna. This is due to the porous characteristics of the wood and to the ball-and-socket profile design of the staves.

Water Seepage will not harm the sauna. The moisture will evaporate once you turn on the heater and the sauna heats up.

If the water marks are bothersome, they can be easily removed with a light sanding (80 or 100 grit)

Manufactured by:



tel: 888-923-9813 | info@leisurecraft.com | web: www.leisurecraft.com

Exterior

Depending on the humidity and weather conditions in your area, the cedar will either shrink or expand based on the amount of moisture absorption. The desired effect is to have the cedar expand into the bands therefore making the sauna staves much tighter. Over time the lumber will weather naturally as a result of sun and rain, it will change into a weathered grey colour. This natural weathering will not harm the wood or impair the sauna's performance.

If you wish to retain the natural color of your Leisurecraft Sauna, Leisurecraft offers cedar sauna stains in 4 amazing colors, Espresso, Limestone Trail, Onyx Gem and Pickled White in convenient 1-gallon pails.

Never treat the interior of the Sauna,



Espresso



Limestone Trail



Onyx Gem



Pickled White



WARRANTY

Leisurecraft warrants our Canadian Timber Collection Saunas against defects in materials and workmanship under normal/residential use for a period of three (3) years, as applicable, from the date of receipt of the product by the original end-user consumer.

This warranty does not apply to normal wear and tear and/or natural weather conditions. This warranty does not cover regular required maintenance of the sauna, (eg. Tightening bands on the barrels, cleaning or staining the sauna)

Refer to your sauna assembly manual for maintenance guidelines.

This warranty does not cover misuse or negligence and the manufacturer, and associated retailers are not liable for any injury or damage caused by the product.

This warranty is a parts only warranty and any service or labor costs would not be considered as part of the 3-year warranty.

Purchaser Name: _____ Date: _____

Purchased From: _____

Manufactured by:

